



GSX250RL/RLX

OWNER'S MANUAL

This manual should be considered a permanent part of the motorcycle and should remain with the motorcycle when resold or otherwise transferred to a new owner or operator. The manual contains important safety information and instructions which should be read carefully before operating the motorcycle.

IMPORTANT

BREAK-IN (RUNNING-IN) INFORMATION FOR YOUR MOTORCYCLE

The first 1600 km are the most important in the life of your motorcycle. Proper break-in operation during this time will help ensure maximum life and performance from your new motorcycle. Suzuki parts are manufactured of high quality materials, and machined parts are finished to close tolerances. Proper break-in operation allows the machined surfaces to polish each other and mate smoothly.

Motorcycle reliability and performance depend on special care and restraint exercised during the break-in period. It is especially important that you avoid operating the engine in a manner which could expose the engine parts to excessive heat.

Please refer to the BREAK-IN (RUNNING-IN) section for specific break-in recommendations.

For further inquiries & concerns, feel free to contact us at:
SUZUKI PHILIPPINES, INCORPORATED
CUSTOMER CARE DEPARTMENT
126 Progress Avenue, Carmelray Industrial
Park 1, Carmelton, Canlubang, Calamba City
4028, Laguna



▲ WARNING/▲ CAUTION/NOTICE/NOTE

Please read this manual and follow its instructions carefully. To emphasize special information, the symbol ▲ and the words **WARNING**, **CAUTION**, **NOTICE** and **NOTE** have special meanings. Pay particular attention to messages highlighted by these signal words:

▲ WARNING

Indicates a potential hazard that could result in death or serious injury.

▲ CAUTION

Indicates a potential hazard that could result in minor or moderate injury.

NOTICE

Indicates a potential hazard that could result in vehicle or equipment damage.

NOTE: Indicates special information to make maintenance easier or instructions clearer.

FOREWORD

Motorcycling is one of the most exhilarating sports and to ensure your riding enjoyment, you should become thoroughly familiar with the information presented in this Owner's Manual before riding the motorcycle.

The proper care and maintenance that your motorcycle requires is outlined in this manual. By following these instructions explicitly you will ensure a long trouble-free operating life for your motorcycle. Your authorized Suzuki dealer has experienced technicians that are trained to provide your machine with the best possible service with the right tools and equipment.

All information, illustrations and specifications contained in this manual are based on the latest product information available at the time of publication. Due to improvements or other changes, there may be some discrepancies in this manual and your motorcycle. Suzuki reserves the right to make changes at any time.

Please note that this manual applies to all specifications or all respective destinations and explains all equipment. Therefore, your model may have different standard features than shown in this manual.

SUZUKI PHILIPPINES, INCORPORATED



TABLE OF CONTENTS

| | |
|---|----------|
| CONSUMER INFORMATION | 1 |
| CONTROLS | 2 |
| FUEL AND ENGINE OIL RECOMMENDATION | 3 |
| BREAK-IN (RUNNING-IN) AND INSPECTION BEFORE RIDING | 4 |
| RIDING TIPS | 5 |
| INSPECTION AND MAINTENANCE | 6 |
| TROUBLESHOOTING | 7 |
| STORAGE PROCEDURE AND MOTORCYCLE CLEANING | 8 |
| SPECIFICATIONS | 9 |
| INDEX | |

CONSUMER INFORMATION

| | |
|--|-----|
| ACCESSORY USE AND MOTORCYCLE LOADING | 1-2 |
| MODIFICATION | 1-4 |
| SAFE RIDING RECOMMENDATION FOR MOTORCYCLE RIDERS | 1-5 |
| LABELS | 1-6 |
| SERIAL NUMBER LOCATION | 1-7 |

CONSUMER INFORMATION

ACCESSORY USE AND MOTORCYCLE LOADING

ACCESSORY USE

The addition of unsuitable accessories can lead to unsafe operating conditions. It is not possible for Suzuki to test each accessory on the market or combinations of all the available accessories; however, your dealer can assist you in selecting quality accessories and installing them correctly. Use extreme caution when selecting and installing the accessories on your motorcycle and consult your Suzuki dealer if you have any questions.

WARNING

Improper installation of accessories or modification of the motorcycle may cause changes in handling which could lead to an accident.

Never use improper accessories, and make sure that any accessories that are used are properly installed. All parts and accessories added to the motorcycle should be genuine Suzuki parts or their equivalent designed for use on this motorcycle. Install and use them according to their instructions. If you have any questions, contact your Suzuki dealer.

ACCESSORY INSTALLATION GUIDELINES

- Install aerodynamic-affecting accessories, such as a fairing, windshield and backrests as low as possible, as close the motorcycle and as near the centre of gravity as is feasible. Check that the mounting brackets and other attachment hardware are rigidly mounted.
 - Inspect for proper ground clearance and bank angle. Inspect that the accessory does not interfere with the operation of the suspension, steering or other control operations.
 - Accessories fitted to the handlebars or the front fork area can create serious stability problems. This extra weight will cause the motorcycle to be less responsive to your steering control. The weight may also cause oscillations in the front end and lead to instability problems. Accessories added to the handlebars or front fork of the motorcycle should be as light as possible and kept to a minimum.
 - Select an accessory which does not limit the freedom of rider movement.
- Select an electric accessory which does not exceed motorcycle's electrical system capacity. Severe overloads may damage the wiring harness or create hazardous situations.
 - Do not pull a trailer or sidecar. This motorcycle is not designed to pull a trailer or sidecar.
 - When you are riding with a passenger, take care so that the passenger's foot does not put on the sari guard.

LOADING GUIDELINES

This motorcycle is primarily intended to carry small items when you are not riding with a passenger. Follow the guidelines below:

- Balance the load between the left and right side of the motorcycle and fasten it securely.
- Keep cargo weight low and as close to the centre of the motorcycle as possible.
- Do not attach large or heavy items to the handlebars, front forks or rear fender.
- Do not install a luggage carrier or a luggage box protruding over the tail end of the motorcycle.
- Do not carry any items that protrude over the tail end of the motorcycle.
- Check that both tyres are properly inflated to the specified tyre pressure for your loading conditions. Refer to page 6-53.

- Improperly loading your motorcycle can reduce your ability to balance and steer the motorcycle. You should ride at reduced speeds, less than 130 km/h, when you are carrying cargo or have added accessories.
- Adjust suspension setting as necessary.

WARNING

Placing objects in the space behind the fairing can interfere with steering and can lose control.

Do not carry any objects in the space behind the fairing.

MODIFICATION

Modification of the motorcycle, or removal of original equipment may render the vehicle unsafe or illegal.

SAFE RIDING RECOMMENDATION FOR MOTORCYCLE RIDERS

Motorcycle riding is great fun and an exciting sport. Motorcycle riding also requires that some extra precautions be taken to ensure the safety of the rider and passenger. These precautions are:

WEAR A HELMET

Motorcycle safety equipment starts with a quality helmet. One of the most serious injuries that can happen is a head injury. ALWAYS wear a properly approved helmet. You should also wear suitable eye protection.

RIDING APPAREL

Loose, fancy clothing can be uncomfortable and unsafe when riding your motorcycle. Choose good quality motorcycle riding apparel when riding your motorcycle.

RIDING CAPACITY

Capacity of this motorcycle is limited to two persons only. Do not admit any riders if there's no seat available, nor load luggages in the space where there is no seat or loading platform.

INSPECTION BEFORE RIDING

Review thoroughly the instructions in the "INSPECTION BEFORE RIDING" section of this manual. Do not forget to perform an entire safety inspection to ensure the safety of the rider and its passenger.

FAMILIARIZE YOURSELF WITH THE MOTORCYCLE

Your riding skill and your mechanical knowledge form the foundation for safe riding practices. We suggest that you practice riding your motorcycle in a non-traffic situation until you are thoroughly familiar with your motorcycle and its controls. Remember practice makes perfect.

KNOW YOUR LIMITS

Ride within the boundaries of your own skill at all times. Knowing these limits and staying within them will help you to avoid accidents.

BE EXTRA SAFETY CONSCIOUS ON BAD WEATHER DAYS

Riding on bad weather days, especially wet ones, requires extra caution. Braking distances double on a rainy day. Stay off the painted surface marks, manhole covers and greasy appearing areas as they can be especially slippery. Use extreme caution at railway crossings and on metal gratings and bridges. Whenever in doubt about road condition, slow down!

RIDE DEFENSIVELY

The most common type of motorcycle accident occurs when a car traveling towards a motorcycle turns round corner in front of the motorcyclist. Ride defensively. Wise motorcyclist uses a strategy of assuming they are invisible to other drivers, even in broad daylight. Wear bright, reflecting clothing. Turn on the headlight and taillight every time even on a bright, sunny day to attract driver's attention. Do not ride in another driver's blind spot.

LABELS

Read and follow all the labels on the motorcycle. Make sure you understand all of the labels. Do not remove any labels from the motorcycle.

SERIAL NUMBER LOCATION

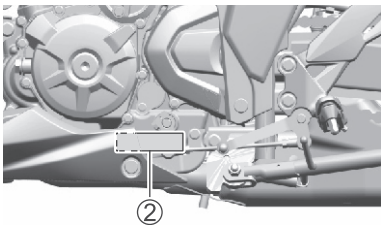
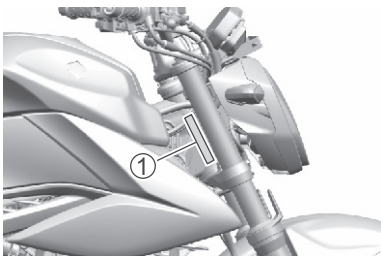

The frame and/or engine serial numbers are used to register the motorcycle. They are also used to assist your dealer when ordering parts or referring to special service information. The frame number ① is stamped on the steering head tube on right hand side. The engine serial number ② is stamped on the crankcase assembly on left hand side.

Please write down the numbers in the box provided below for your future reference.

Frame Number:

Engine Number:



CONTROLS

| | |
|------------------------------------|------|
| LOCATION OF PARTS | 2-2 |
| KEY | 2-5 |
| IGNITION SWITCH | 2-5 |
| INSTRUMENT PANEL | 2-8 |
| LEFT HANDLEBAR | 2-24 |
| RIGHT HANDLEBAR | 2-26 |
| FUEL TANK CAP | 2-29 |
| GEARSHIFT LEVER | 2-30 |
| REAR BRAKE PEDAL | 2-31 |
| SEAT LOCK AND HELMET HOLDERS | 2-32 |
| SIDE STAND | 2-35 |
| REAR SUSPENSION | 2-36 |

CONTROLS

LOCATION OF PARTS

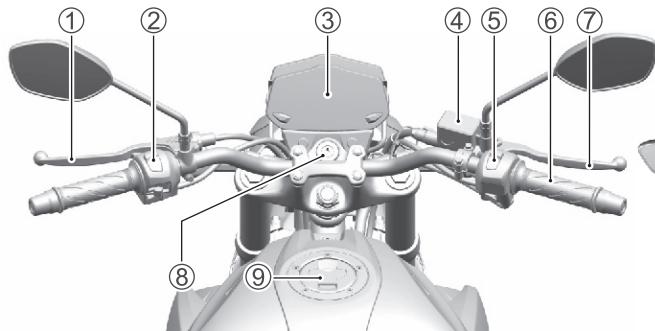

GSX250RL

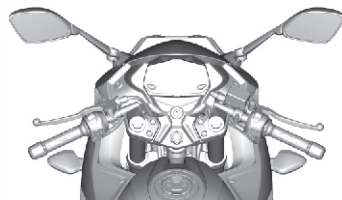

GSX250FRL

- ① Clutch lever
- ② Left handlebar switches
- ③ Instrument panel
- ④ Front brake fluid reservoir
- ⑤ Right handlebar switches

- ⑥ Throttle grip
- ⑦ Front brake lever
- ⑧ Ignition switch
- ⑨ Fuel tank cap

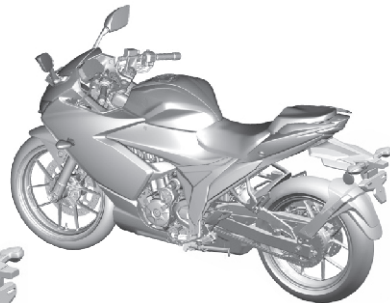
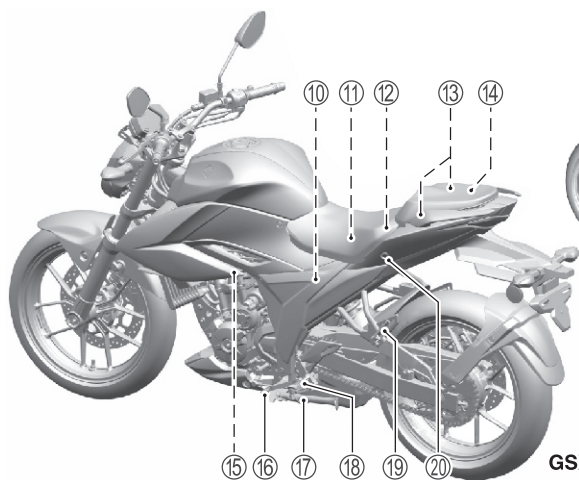

GSX250FRL

GSX250RL

- ⑩ Battery
- ⑪ Air cleaner
- ⑫ Fuses
- ⑬ Helmet holder
- ⑭ Tools
- ⑮ Spark plug

- ⑯ Gearshift lever
- ⑰ Side stand
- ⑱ Footrests
- ⑲ Passenger footrests
- ⑳ Seat lock

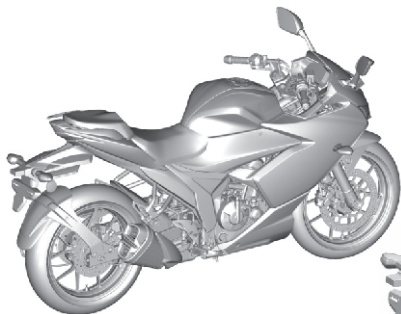

GSX250FRL

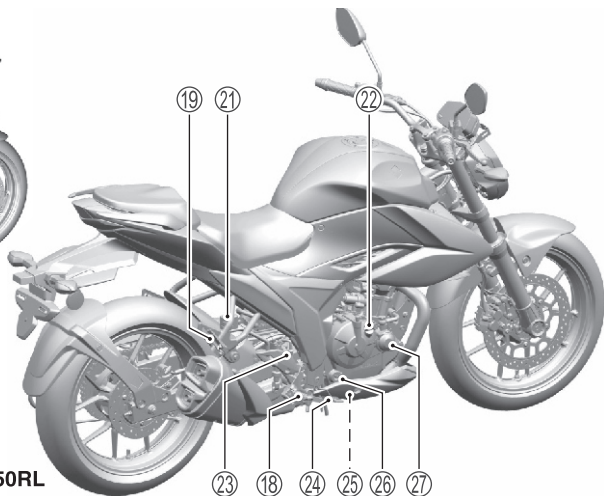

GSX250RL

- ②① Rear brake fluid reservoir
- ②② Engine oil filler cap
- ②③ Rear brake light switch
- ②④ Rear brake pedal
- ②⑤ Engine oil drain plug

- ②⑥ Engine oil inspection window
- ②⑦ Engine oil filter

KEY

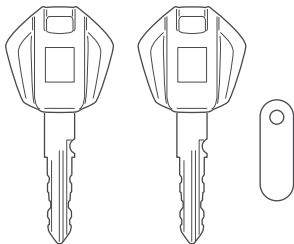

This motorcycle comes equipped with a main ignition key and a spare one. Keep the spare key in a safe place.

IGNITION SWITCH

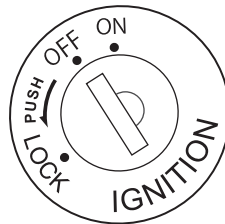

The ignition switch has three positions:

“OFF” POSITION

All electrical circuits are cut off. The engine will not start. The key can be removed.

“ON” POSITION

The ignition circuit is completed and the engine can now be started. The key cannot be removed from the ignition switch in this position.

“LOCK” POSITION

To lock the steering, turn the handlebar all the way to the left. Push down and turn the key to the “LOCK” position and remove the key. All electrical circuits are cut off.

NOTE:

- Move the handlebar to the right and left, to make sure that the steering has been locked securely.
- When it cannot be locked easily, turn the key to the “LOCK” position, moving the handlebar slightly to the right.

WARNING

Turning the ignition switch to the “LOCK” position while the motorcycle is moving can be hazardous. Moving the motorcycle while the steering is locked can be hazardous. You could lose your balance and fall, or you could drop the motorcycle.

Stop the motorcycle and place it on the side stand before locking the steering. Never attempt to move the motorcycle when the steering is locked.

WARNING

If the motorcycle falls down due to a slip or collision, unexpected damage to the motorcycle could cause the engine to keep running, which could result in a fire, or could result in injury from moving parts such as the rear wheel.

If the motorcycle falls down, turn the ignition switch off immediately. Ask your authorized Suzuki dealer to inspect the motorcycle for unseen damage.

INSTRUMENT PANEL

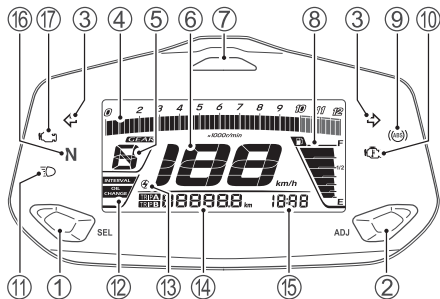

The engine rpm indicator light ⑦, ABS indicator light ⑨, engine temperature indicator light ⑩, malfunction indicator light ⑰ and LCD's work as follows to confirm their function when the ignition switch is turned to the "ON" position.

- The engine rpm indicator light ⑦, engine temperature indicator light ⑩, malfunction indicator light ⑰ come on for 3 seconds.
- All LCD segments appear and then show the normal display.

The display indicates the opening pattern shown below:

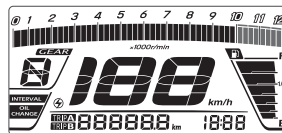

All LCD display

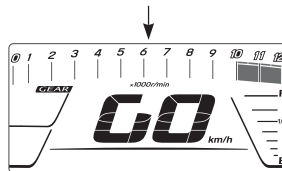

GO

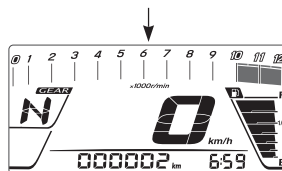

Normal display

TURN SIGNAL INDICATOR LIGHT “”

③

When the turn signals are being operated either to the right or to the left, the indicator will blink intermittently.

NOTE: If a turn signal light is not operating properly due to bulb filament or circuit failure, the indicator light blinks more quickly to notify the rider of the existence of problem.

TACHOMETER ④

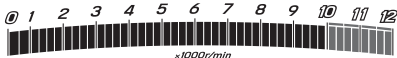

The tachometer indicates the engine speed in revolutions per minute (r/min).

GEAR POSITION INDICATOR ⑤



The gear position indicator indicates gear position. This indicator displays “N” when the transmission is in neutral.

SPEEDOMETER ⑥



The speedometer indicates the road speed in kilometers per hour.

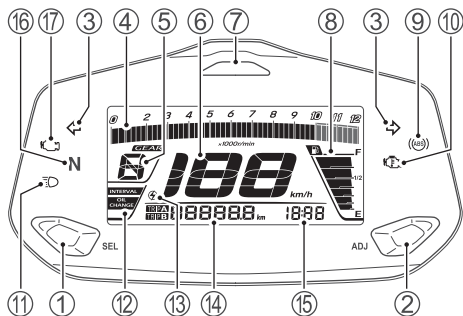

ENGINE RPM INDICATOR ⑦

The engine rpm indicator light ⑦ will light or blink when the engine speed reaches a preset engine rpm.

LIGHT/BLINK/NO LIGHT Mode Selection

1. To enter the selection mode, turn on the ignition switch and press and hold the SEL button ① for more than 2 seconds to change the mode.
2. Push the ADJ button ② to change the lighting mode. The mode changes as follows:
LIGHT → BLINK → NO LIGHT → LIGHT.
The engine rpm indicator light ⑦ comes on steady in the LIGHT mode and blinks in the BLINK mode. The engine rpm indicator mark “⚡” ⑬ comes on when the LIGHT or BLINK mode is selected.
3. Push the SEL button ① to fix the selected mode. Change to preset rpm selection when you select the LIGHT mode or BLINK mode.
4. While in the mode selection, if the motorcycle reaches speed of more than 10 km/h or the ignition switch is turned to “OFF” position, the mode selection is cancelled.

Preset RPM Selection

1. Select the LIGHT mode or BLINK mode.
2. Push the ADJ button ② to select a preset rpm. Push the ADJ button ② to change the preset rpm from 4000 r/min to 10000 r/min in steps of 500 r/min.
3. Push the SEL button ① to fix the selected setting.

WARNING



Changing the display while riding can be hazardous. Removing a hand from the handlebars can reduce your ability to control the motorcycle.

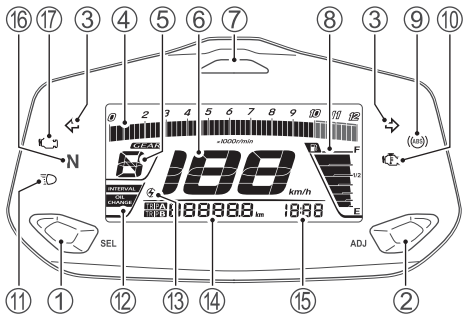



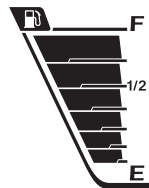

Never change the display while riding. Keep both hands on the handlebars.

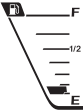

FUEL LEVEL INDICATOR “” ⑧



The fuel level indicator indicates the amount of fuel remaining in the fuel tank. The fuel level indicator displays all 6 segments when the fuel tank is full. The “” mark blinks when the fuel drops below 3.0 L. The “” mark and segment blink when the fuel drops below 1.2 L.

| Fuel tank | Approximately 1.2 L | Approximately 3.0 L | Full |
|--|--|--|---|
| Segments | Blink  |  |  |
|  mark | Blink  | Blink  |  |

NOTE: The fuel level indicator will not indicate correctly when the motorcycle is placed with the side stand. Turn the ignition switch to the “ON” position when the motorcycle is held upright.

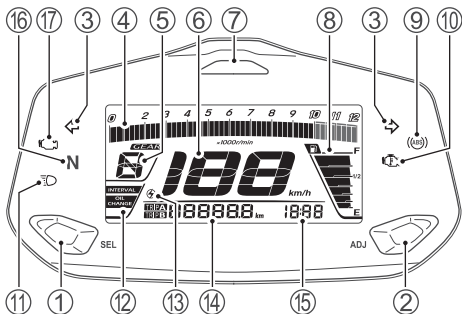

ABS INDICATOR LIGHT “(ABS)” ⑨

This indicator normally comes on when the ignition switch is turned “ON” and goes off after the motorcycle speed exceeds 5 km/h.

If there is a problem with the ABS (Anti-lock Brake System), this indicator light blinks or comes on. The ABS does not operate when the ABS indicator light is on or blinking.

NOTE: If the ABS indicator light goes off after you start the motorcycle but before you begin riding, check the ABS indicator light function by turning off and on the ignition switch. The ABS indicator light can go off if the engine is revved at high speed before you begin riding. If the ABS indicator light does not come on when the ignition switch is turned on, you should have the system checked by an authorized Suzuki dealer as soon as possible.

WARNING

Riding the motorcycle with the ABS indicator light on can be hazardous.

If the ABS indicator light blinks or comes on while riding, stop the motorcycle in a safe place and turn off the ignition switch. Turn the ignition switch “ON” after a while and check if the indicator light comes on.

- If the indicator light goes off after starting to ride, the ABS will be functioning.
- If it does not go off after starting to ride, ABS is not functioning, and the brakes provide normal stopping ability. You should have the system checked by an authorized Suzuki dealer as soon as possible.

ENGINE TEMPERATURE INDICATOR LIGHT “” ⑩

The engine temperature indicator light comes on for 3 seconds when the ignition switch is turned to the “ON” positions. When the engine temperature gets too much high, the engine temperature indicator light comes on.

NOTICE

Riding the motorcycle with the engine temperature indicator lit can cause serious engine damage due to overheating.

If the engine temperature indicator light comes on, stop the engine to let it cool. Do not run the engine until the engine temperature indicator light goes off.

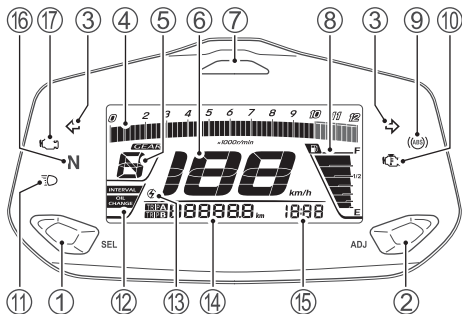

HIGH BEAM INDICATOR LIGHT “≡▷” ⑪

This blue indicator light will be lit when the headlight high beam is turned on.

OIL CHANGE INDICATOR ⑫



The oil change indicator comes on to remind you to change the engine oil. The preset interval is adjustable between 500 km and 5000 km in 500 km steps. Reset the indicator after changing the engine oil to turn off the indicator.

To reset the oil change indicator:

1. Turn off the ignition switch.
2. Press and hold the SEL button ① and turn the ignition switch to the "ON" position and hold the SEL button ① for 4 seconds.
3. The oil change counter will reset and the OIL CHANGE indicator blinks 3 times and goes off.

To preset the oil change interval:

1. Set the meter to odometer, then press and hold the ADJ button ② for 2 seconds until the INTERVAL and OIL CHANGE indicators blink.
2. Push the SEL button ① to decrease the interval from 5000 km to 500 km in 500 km steps. Push the ADJ button ② to increase the interval from 500 km to 5000 km in 500 km steps.
3. Press and hold the SEL button ① and the ADJ button ② for 2 seconds to exit the preset.

NOTE:

- Reset the indicator after initial oil replacement.
- The indicator can be reset even if the odometer does not reach 1000 km.
- Reset the indicator after oil replacement even if the indicator is not displayed.
- Preset interval change does not reset the indicator.
- The preset interval is factory adjusted to 5000 km.

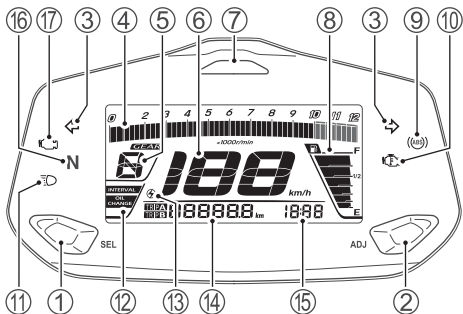

ODOMETER/TRIP METER ⑭



The display has 3 functions; odometer and 2 trip meters. When the ignition switch is turned to the “ON” position, the test pattern shown below is displayed. The display is memorized when the ignition switch is turned off and the memorized display appears when the ignition switch is turned on again.

To change the display, push the SEL button
①. The display changes in the order below.

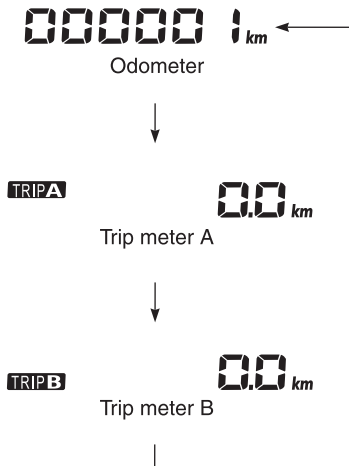

Odometer

The odometer registers the total distance that the motorcycle has been ridden. The odometer ranges from 0 to 999999.

NOTE: The odometer display locks at 999999 when the total distance exceeds 999999.

Trip Meters

The 2 trip meters are resettable odometers. They can register 2 kinds of distances at the same time. For instance, trip meter A can register the trip distance and trip meter B can register the distance between fuel stops.

To reset the meter to zero, push the ADJ button ② for 2 seconds while the display indicates the trip meter A, or B, you want to reset.

NOTE: When the trip meter exceeds 9999.9, the trip meter will return to 0.0 and start counting again.

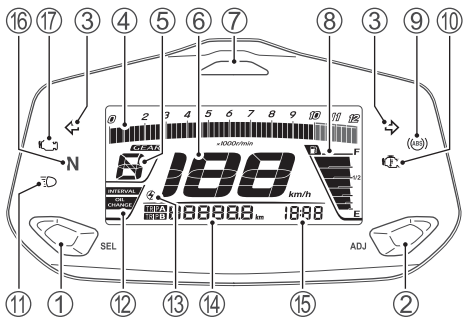

⚠ WARNING

Operating the display while riding can be hazardous. Removing a hand from the handlebars can reduce your ability to control the motorcycle.

Always keep both hands on the handlebars during riding.

CLOCK ⑮



Time is shown when the ignition switch is in the “ON” position. The clock has a 12-hour display. Follow the procedure below to adjust the clock.

1. Press and hold the SEL button ① and ADJ button ② simultaneously for 2 seconds until the hour and minute display blinks.
2. Adjust the hour display by pushing the SEL button ①.
3. Adjust the minute display by pushing the ADJ button ②.
4. Press and hold the SEL button ① and ADJ button ② simultaneously for 2 seconds to return to the clock mode.

NOTE:

- When the button is pressed and held, display will increase continuously.
- The clock can be adjusted when the ignition switch is in the “ON” position.
- This clock is powered by the battery of the motorcycle. If your motorcycle is to be left unused more than two months, remove the battery from the motorcycle.

NEUTRAL INDICATOR LIGHT “N” ⑯

The green light will come on when the transmission is in neutral. The light will go out when you shift into any gear other than neutral.

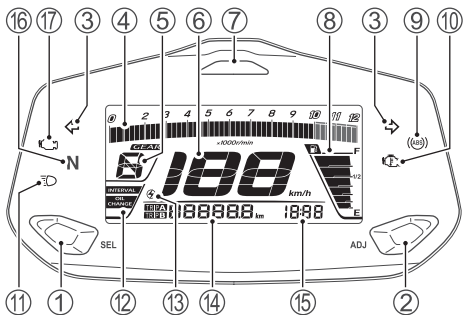

MALFUNCTION INDICATOR LIGHT “” ⑰



If the fuel injection system fails, the malfunction indicator light ⑰ comes on and the display indicates “FI” in the odometer display area in the following two modes;

- A. The display ⑭ in the odometer display area alternately indicates “FI” and the odometer/trip meter reading, and the malfunction indicator light ⑰ comes on and remains lit.
- B. The display ⑭ in the odometer display area indicates “FI” continuously and the malfunction indicator light ⑰ blinks.

The engine may continue to run in mode A, but the engine will not run in mode B.

NOTICE

The malfunction indicator light comes on to indicate a problem with the fuel injection system.

If the display indicates “FI” and the malfunction indicator light comes on, have your authorized Suzuki dealer or a qualified mechanic inspect the fuel injection system as soon as possible.

NOTE:

- If the display indicates “FI” continuously and the malfunction indicator light blinks, the engine will not start.
- If the malfunction indicator light comes on and fast blinks 3 times, the battery voltage is lower. Ask your authorized Suzuki dealer to inspect the motorcycle.

CHEC

When the display ⑭ indicates “CHEC” in the odometer display area, check the following items;

- Make sure that the engine stop switch is in the “” position.

If the display still indicates “CHEC” after checking the above items, inspect the ignition fuse and the connection of the lead wire couplers.

LEFT HANDLEBAR

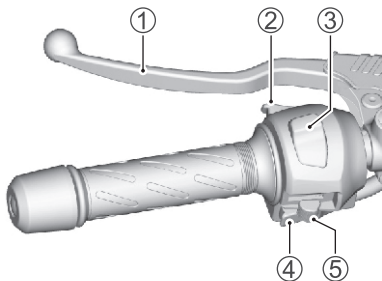

CLUTCH LEVER ①

The clutch lever is used for disengaging the drive to the rear wheel when starting the engine or shifting the transmission gear. Squeezing the lever disengages the clutch.

HEADLIGHT FLASHER SWITCH ②

Press the switch to flash the headlight high beam. The headlight high beam will be lit when the dimmer switch is in “” position.

DIMMER SWITCH ③

“” position

The headlight low beam turns on.

“” position

The headlight high beam turns on. The high beam indicator light also comes on.

NOTICE

Do not put objects in front of the headlight or taillight when they are on, and do not cover with clothes when the motorcycle is stopped.

This may cause melting of the lens or damage to the object by the heat from the lens.

NOTICE



Sticking tape or placing objects in front of the headlight can obstruct headlight heat radiation. This can result in headlight damage.

Do not stick tape on the headlight or place objects in front of the headlight.

HORN SWITCH “” ④

Press the switch to sound the horn.

TURN SIGNAL LIGHT SWITCH “” ⑤

Moving the switch to the “” position will flash the left turn signals. Moving the switch to the “” position will flash the right turn signals. The indicator light will also flash intermittently. To cancel turn signal operation, push the switch in.

WARNING

Failure to use the turn signals, and failure to turn off the turn signals can be hazardous. Other drivers may misjudge your course and this may result in an accident.

Always use the turn signals when you intend to change lanes or make a turn. Be sure to turn off the turn signals after completing the turn or lane change.

RIGHT HANDLEBAR

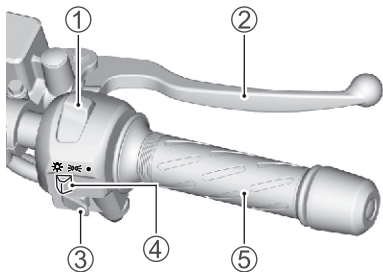

ENGINE STOP SWITCH ①

“~~⊗~~” position

The ignition circuit is off. The engine cannot start or run.

“⊗” position

The ignition circuit is on and the engine can run.

NOTICE

Changing the engine stop switch from ⊗ to ~~⊗~~ or from ⊗ to ~~⊗~~ to ⊗ while riding may damage to the engine or the catalytic converter (if equipped).

Do not use the engine stop switch except for an emergency.

FRONT BRAKE LEVER ②

Apply the front brake by squeezing the front brake lever towards the grip. The brake light will come on when the lever is squeezed.

This motorcycle is equipped with a disk brake system and excessive pressure is not required to slow the machine down properly.

ELECTRIC STARTER SWITCH “” ③

This switch is used for operating the starter motor. With the engine stop switch in the “” position and the transmission in neutral, squeeze the clutch lever and push the electric starter switch to start the engine.

NOTICE

Engaging the starter motor for more than five seconds at a time can damage the starter motor and wiring harness from overheating.

Do not engage the starter motor for more than five seconds at a time. If the engine does not start after several attempts, check the fuel supply and ignition system. Refer to the TROUBLESHOOTING section in this manual.

NOTICE

If the neutral indicator light and the gear position indicator are not giving proper indications, starting the engine can cause serious engine damage.

Before starting the engine, make sure of the followings:

- When the neutral indicator light comes on, the gear position indicator should indicate “N” (Neutral).
- When the neutral indicator light goes off, the gear position indicator should indicate either “1”, “2”, “3”, “4”, “5” or “6”.
- If the neutral indicator light and the gear position indicator are not working properly, consult your Suzuki dealer.

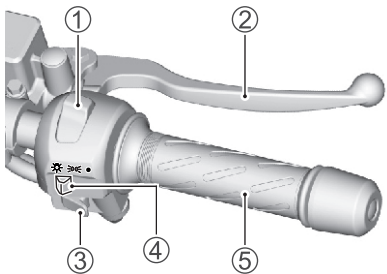

Suzuki Easy Start System

Suzuki Easy Start System permits engine start by simple one-push action on the electric starter switch. When the clutch lever is squeezed, the engine can be started.

NOTE:

- When the electric starter switch is pushed, the starter motor will continue turning for a few seconds even when you release your hand from the switch. After a few seconds, or when the engine is started, the starter motor will stop automatically.

- Depending on the condition of the battery, the engine might not start easily by Suzuki Easy Start System. If the engine is difficult to start, squeeze the clutch lever and continue pressing the electric starter switch to start up the engine. If the engine fails to start up, the battery will most likely lose power. In this case, charge or change the battery.

LIGHT SWITCH ④ (If equipped)

“☀” position

All lights come on

“☁” position

Position light, taillight and license plate light
Come on.

“●” position

All light go off.

THROTTLE GRIP ⑤

Engine speed is controlled by the position of the throttle grip. Twist it toward you to increase engine speed. Turn it away from you to decrease the engine speed.

FUEL TANK CAP

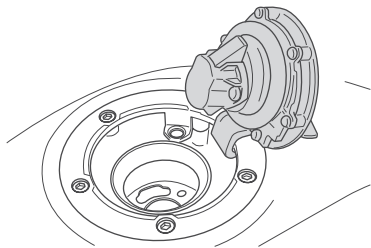
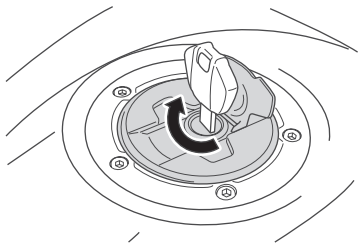

To open the fuel tank cap, insert the ignition key into the lock and turn it clockwise. With the key inserted, lift up with the key and open the fuel tank cap. To close the fuel tank cap, push the cap down firmly with the key in the cap lock.

Use fresh gasoline when filling up the fuel tank. Do not use bad gasoline which is contaminated with dirt, dust, water or other liquid. Be careful that dirt, dust or water do not enter the fuel tank when refueling.

Fuel tank capacity: 12 L

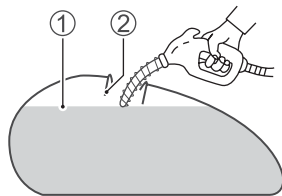

- ① Fuel level
- ② Filler neck

⚠ WARNING

If you overfill the fuel tank, fuel may overflow when it expands due to engine heat or heating by the sun. Fuel that overflows can catch fire.

Stop adding fuel when the fuel level reaches the bottom of the filler neck.

⚠ WARNING

Failure to follow safety precautions when refueling could result in a fire or cause you to breathe toxic fumes.

Refuel in a well ventilated area. Make sure the engine is off and avoid spilling fuel on a hot engine. Do not smoke, and make sure there are no open flames or sparks in the area. Avoid breathing gasoline vapours. Keep children and pets away when you refuel the motorcycle.

GEARSHIFT LEVER

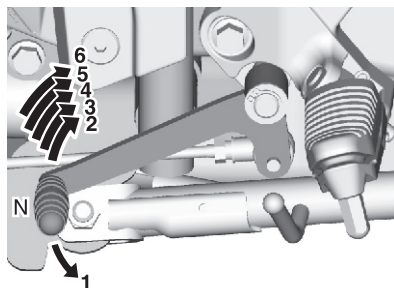

This motorcycle has a 6-speed transmission which operates as shown. To shift properly, squeeze the clutch lever and close the throttle at the same time you operate the gearshift lever. Lift the gearshift lever to upshift and depress the lever to downshift. Neutral is located between 1st and 2nd gear. When neutral is desired, depress or lift the lever halfway between 1st and 2nd gear.

NOTE: When the transmission is in neutral, the green indicator light on the instrument panel will be lit. However, even though the light is illuminated, cautiously release the clutch lever slowly to make sure that the transmission is positively in neutral.

Reduce the motorcycle speed before down-shifting. When down-shifting, the engine speed should be increased before the clutch is engaged. This will prevent unnecessary wear on the drive train components and the rear tyre.

REAR BRAKE PEDAL

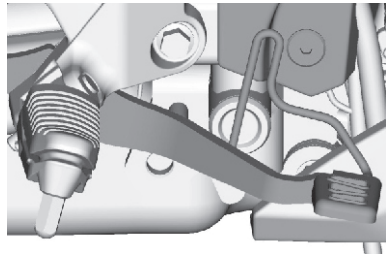

Depressing the rear brake pedal will apply the rear brake. The brake light will be illuminated when the rear brake is operated.

SEAT LOCK AND HELMET HOLDERS

SEAT LOCK

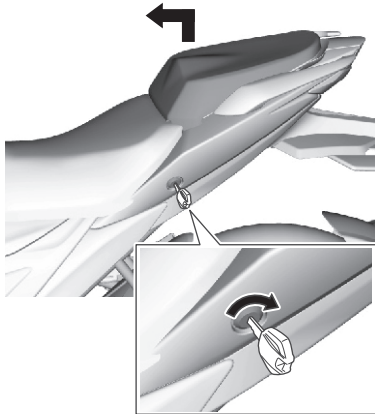

The seat lock is located under the left frame cover. To remove the rear seat, insert the ignition key into the lock and turn it clockwise. Raise the front end of the seat and slide it forward.

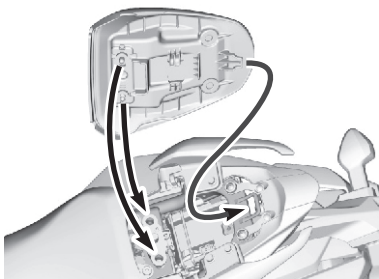

To reinstall the rear seat, slide the seat hooks into the seat hook retainers and push down firmly until the seat snaps into the locked position.

WARNING

Failure to install the seat properly could allow the seat to move and cause loss of rider control.

Latch the seat securely in its proper position.

FRONT SEAT REMOVAL

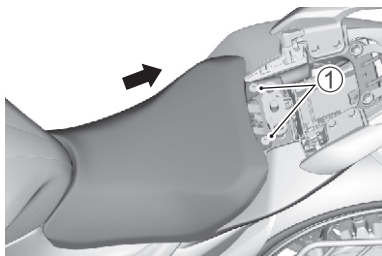

1. Remove the rear seat. Remove the bolts ①.
2. Raise the rear end of the seat and slide it backward.

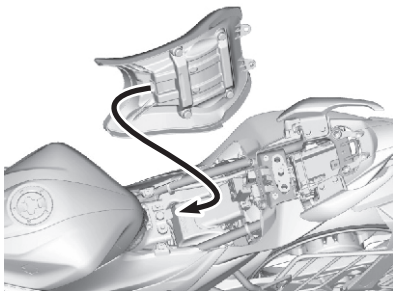

To reinstall the front seat, slide the seat hooks into the seat hook retainers on the frame and tighten the bolts securely.

⚠ WARNING

Failure to install the seat properly could allow the seat to move and cause loss of rider control.

Fasten the seat securely in its proper position.

HELMET HOLDERS

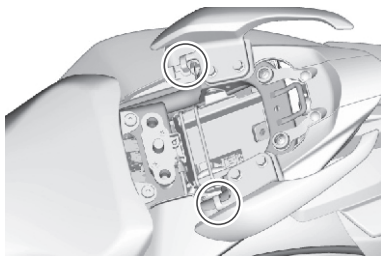

There are helmet holders under the rear seat. To use it, remove the rear seat, hook your helmet fastener ring to the holder and refit the rear seat.

WARNING

Riding with a helmet fastened to the helmet holder can interfere with rider control.

Never carry a helmet fastened to a helmet holder. Fix the helmet securely atop the seat if you must carry it.

SIDE STAND

This motorcycle is equipped with a side stand.

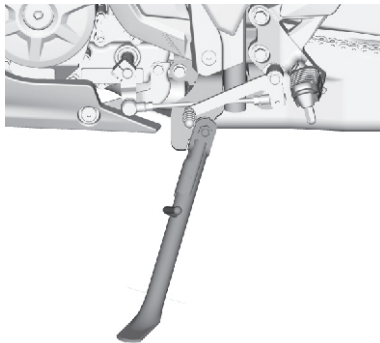

The motorcycle has a side stand. To place the motorcycle on the side stand, place your right foot on the end of the side stand and push down firmly until the stand pivots fully through its arc and comes to rest against its stop.

WARNING

Riding with the side stand incompletely retracted can result in an accident when you turn left.

Always retract the side stand completely before starting off.

NOTICE

If you do not take proper precautions when parking, the motorcycle can fall over.

Park the motorcycle on firm, level ground whenever possible. If you must park on an incline, aim the front of the motorcycle uphill and put the transmission into 1st gear to reduce the possibility of rolling off the side stand.

REAR SUSPENSION

SPRING PRE-LOAD ADJUSTMENT

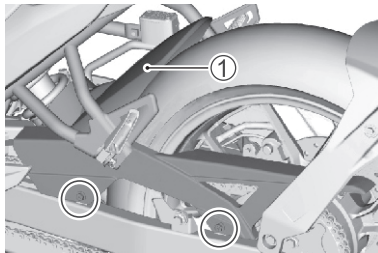

Remove the right and left bolts. Remove the chain case ①.

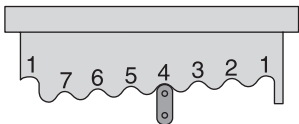
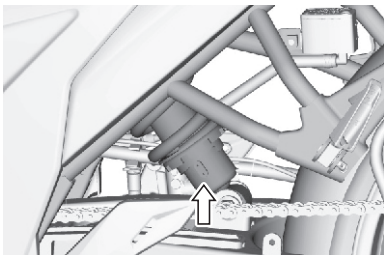

The rear suspension spring pre-load is adjustable to compensate for rider, load, riding style and road conditions. The spring pre-load is adjustable to 7 positions. To change the spring pre-load setting, place the motorcycle on the side stand. Twist the spring tension ring to the desired position with the adjustable wrench. Position 1 provides the softest spring tension and position 7 provides the stiffest. This motorcycle is delivered from the factory with its adjuster set on position 4.



FUEL AND ENGINE OIL RECOMMENDATION

| | |
|--------------------------------------|-----|
| FUEL OCTANE RATING | 3-2 |
| OXYGENATED FUEL RECOMMENDATION | 3-2 |
| ENGINE OIL | 3-4 |

FUEL AND ENGINE OIL RECOMMENDATION

FUEL OCTANE RATING

Use unleaded gasoline with an octane rating of 91 or higher (Research method). Unleaded gasoline can extend spark plug life and exhaust components life.

NOTE:

- If the engine develops some trouble like lack of acceleration or insufficient power, the cause may be due to the fuel the motorcycle uses. In such case, try changing to a different gas station. If the situation is not improved by changing, consult your Suzuki dealer.
- If pinking or knocking is experienced, substitute higher octane grade gasoline or another brand, because there are differences between brands.

OXYGENATED FUEL RECOMMENDATION

Oxygenated fuels which meet the minimum octane requirement and the requirements described below may be used in your motorcycle without jeopardizing the New Vehicle Limited Warranty.

NOTE: Oxygenated fuels are fuels which contain oxygen carrying additives such as alcohol.

Gasoline/Ethanol Blends

Blends of unleaded gasoline and ethanol (grain alcohol), also known as "GASOHOL", are commercially available in some areas. Blends of this type may be used in your motorcycle if they are no more than 10% ethanol. Make sure this gasoline-ethanol blend has octane ratings no lower than those recommended for gasoline.

Use the recommended gasoline.

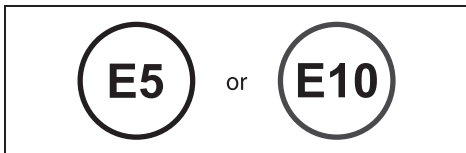

NOTE:

- To help minimize air pollution, Suzuki recommends that you use oxygenated fuels.
- Be sure that any oxygenated fuel you use has recommended octane ratings.
- If you are not satisfied with the drivability of your motorcycle when you are using an oxygenated fuel, or if engine pinging is experienced, substitute another brand as there are differences between brands.

NOTICE

Spilled gasoline containing alcohol can damage the painted surfaces of your motorcycle.

Be careful not to spill any fuel when filling the fuel tank. Wipe spilled gasoline up immediately.

NOTICE

Do not use leaded gasoline.

Use of leaded gasoline causes the catalytic converter to malfunction.

ENGINE OIL

Use Suzuki genuine engine oil or equivalent. If Suzuki genuine engine oil is not available, select a proper engine oil according to the following guideline.

Oil quality is a major contributor to your engine's performance and life. Always select good quality engine oil. Use oil with an API (American Petroleum Institute) classification of SG, SH, SJ, SL, SM or SN with a JASO classification of MA.

| SAE | API | JASO |
|--------|-----------------------------|------|
| 10W-40 | SG, SH, SJ, SL, SM or SN | MA |

API: American Petroleum Institute

JASO: Japanese Automobile Standards Organization

SAE Engine Oil Viscosity

Suzuki recommends the use of SAE 10W-40 engine oil. If SAE 10W-40 engine oil is not available, select an alternative according to the following chart.

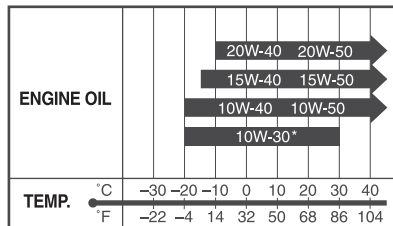

* USE ONLY SG, SH, SJ or SL.

JASO T903

The JASO T903 standard is an index to select engine oils for 4-stroke motorcycle and ATV engines. Motorcycle and ATV engines lubricate clutch and transmission gears with engine oil. JASO T903 specifies performance requirements for motorcycle and ATV clutches and transmissions.

There are two classes, MA and MB. The oil container shows the classification as follows.

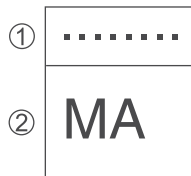

- ① Code number of oil sales company
- ② Oil classification

Energy Conserving

Suzuki does not recommend the use of “ENERGY CONSERVING” or “RESOURCE CONSERVING” oils. Some engine oils which have an API classification of SH, SJ, SL, SM or SN have an “ENERGY CONSERVING” or “RESOURCE CONSERVING” indication in the API classification donut mark. These oils can affect engine life and clutch performance.

API SG, SH, SJ, SL, SM or SN



Recommended

API SH, SJ, SL or SM

API SN



Not recommended

BREAK-IN (RUNNING-IN) AND INSPECTION BEFORE RIDING

| | |
|--|-----|
| MAXIMUM THROTTLE OPENING RECOMMENDATION | 4-2 |
| VARY THE ENGINE SPEED | 4-2 |
| BREAKING IN THE NEW TYRES | 4-3 |
| AVOID CONSTANT LOW SPEED | 4-3 |
| OBSERVE YOUR FIRST AND MOST CRITICAL SERVICE | 4-4 |
| INSPECTION BEFORE RIDING | 4-4 |

BREAK-IN (RUNNING-IN) AND INSPECTION BEFORE RIDING

The opening explains how important proper break-in is to achieve maximum life and performance from your new Suzuki. The following guidelines explain proper break-in procedures.

MAXIMUM THROTTLE OPENING RECOMMENDATION

The table below shows the maximum throttle opening recommendation during the break-in period.

| | | |
|---------|---------|-------------------|
| Initial | 800 km | Below 5000 r/min |
| Up to | 1600 km | Below 7500 r/min |
| Over | 1600 km | Below 10000 r/min |

VARY THE ENGINE SPEED

The engine speed should be varied and not held at a constant speed. This allows the parts to be “loaded” with pressure, and then unloaded, allowing the parts to cool. This aids the mating process of the parts. It is essential that some stress be placed on the engine components during break-in to ensure this mating process. Do not, though, apply excessive load on the engine.

BREAKING IN THE NEW TYRES

New tyres need proper break-in to assure maximum performance, just as the engine does. Wear in the tread surface by gradually increasing your cornering lean angles over the first 160 km before attempting maximum performance. Avoid hard acceleration, hard cornering, and hard braking for the first 160 km.

WARNING

Failure to perform break-in of the tyres could cause tyre slip and loss of control.

Use extra care when riding on new tyres. Perform proper break-in of the tyres as described in this section and avoid hard acceleration, hard cornering, and hard braking for the first 160 km.

AVOID CONSTANT LOW SPEED

Operating the engine at constant low speed (light load) can cause parts to glaze and not seat in. Allow the engine to accelerate freely through the gears, without exceeding the recommended maximum limits. Do not, however, use full throttle for the first 1600 km.

OBSERVE YOUR FIRST AND MOST CRITICAL SERVICE

The 1000 km service is the most important service your motorcycle will receive. During break-in, all of the engine components will have worn in and all of the other parts will have seated in. All adjustments will be restored, all fasteners will be tightened, and the dirty engine oil and engine oil filter will be replaced.

Timely performance of the 1000 km service will ensure optimum service life and performance from the engine.

NOTE: The 1000 km service should be performed as outlined in the **INSPECTION AND MAINTENANCE** section of this Owner's Manual. Pay particular attention to the **CAUTION** and **WARNING** messages in that section.

INSPECTION BEFORE RIDING

⚠ WARNING

Failure to inspect your motorcycle before riding and to properly maintain your motorcycle increases the chances of an accident or equipment damage.

Always inspect your motorcycle each time you use it to make sure it is in safe operating condition. Refer to the **INSPECTION AND MAINTENANCE section in this owner's manual.**

WARNING

If you operate this motorcycle with improper tyres or improper or uneven tyre pressure, you may lose control of the motorcycle. This will increase your risk of an accident.







Always use tyres of the size and type specified in this owner's manual. Always maintain proper tyre pressure as described in the **INSPECTION AND MAINTENANCE** section.







Before riding the motorcycle, be sure to check the following items. Never underestimate the importance of these checks. Perform all of them before riding the motorcycle.

WARNING

Checking maintenance items when the engine is running can be hazardous. You could be severely injured if your hands or clothing get caught in moving parts.

Shut the engine off when performing maintenance checks, except when checking the lights and throttle.

| WHAT TO CHECK | CHECK FOR: |
|---|--|
| Steering | <ul style="list-style-type: none"> • Smoothness • No restriction of movement • No rattle or looseness |
| Throttle ( 6-36) | <ul style="list-style-type: none"> • Correct play in the throttle cable • Smooth operation and positive return of the throttle grip to the closed position |
| Clutch ( 6-38) | <ul style="list-style-type: none"> • Correct play in the cable • Smooth and progressive action |
| Brakes ( 2-26, 2-31, 6-44) | <ul style="list-style-type: none"> • Proper pedal and lever operation • Fluid level in the reservoir to be above "MIN (lower)" line • Correct pedal and lever play • No "sponginess" • No fluid leakage • Brake pads not to be worn down to the limit line |
| Suspensions ( 2-36) | <ul style="list-style-type: none"> • Smooth movement • No oil leakage |
| Fuel ( 2-12) | Enough fuel for the planned distance of operation |
| Drive chain ( 6-39) | <ul style="list-style-type: none"> • Proper tension or slack • Adequate lubrication • No excessive wear or damage |

| | |
|---|---|
| Tyres ( 6-52) | <ul style="list-style-type: none"> • Correct pressure • Adequate tread depth • No cracks or cuts |
| Engine oil ( 6-30) | Correct level |
| Lighting ( 2-5, 2-8, 2-24) | Operation of all lights and indicators |
| Engine stop switch ( 2-26) | Correct function |
| Horn ( 2-25) | Correct function |
| Windshield (GSX250FRL) ( 8-7) | Good visibility |

RIDING TIPS

| | |
|------------------------------|-----|
| STARTING THE ENGINE | 5-2 |
| STARTING OFF | 5-4 |
| USING THE TRANSMISSION | 5-6 |
| RIDING ON HILLS | 5-7 |
| STOPPING AND PARKING | 5-8 |

RIDING TIPS

STARTING THE ENGINE

Before attempting to start the engine, make sure:

- The transmission is in neutral.
- The engine stop switch is in the “” position.

WARNING

Starting the engine improperly can be hazardous. Starting the engine with the side stand released can move motorcycle forward as soon as engine starts.

Place the motorcycle on the side stand before starting the engine and do not release the side stand until engine revs at idling speed.

NOTICE

If the neutral indicator light and the gear position indicator are not giving proper indications, starting the engine can cause serious engine damage.

Before starting the engine, make sure of the followings:

- When the neutral indicator light comes on, the gear position indicator should indicate “N” (Neutral).
- When the neutral indicator light goes off, the gear position indicator should indicate either “1”, “2”, “3”, “4”, “5” or “6”.
- If the neutral indicator light and the gear position indicator are not working properly, consult your Suzuki dealer.

When the Engine is Cold or Warm:

1. Squeeze the clutch lever.
2. Close the throttle completely and push the electric starter switch.

When the Engine is Hard to Start:

1. Squeeze the clutch lever.
2. Open the throttle approximately 1/8 turn and push the electric starter switch.

 **WARNING**

Exhaust gas contains carbon monoxide, a dangerous gas that is difficult to detect because it is colourless and odorless. Breathing carbon monoxide can cause death or severe injury.

Never start the engine or let it run indoors or where there is little or no ventilation.

NOTICE

Running the engine too long without riding may cause the engine to overheat. Overheating can result in damage to internal engine components and discoloration of exhaust pipes.

Shut the engine off if you cannot begin your ride promptly.

Suzuki Easy Start System

Suzuki Easy Start System permits engine start by simple one-push action on the electric starter switch. When the clutch lever is squeezed, the engine can be started.

NOTE:

- When the electric starter switch is pushed, the starter motor will continue turning for a few seconds even when you release your hand from the switch. After a few seconds, or when the engine is started, the starter motor will stop automatically.
- Depending on the condition of the battery, the engine might not start easily by Suzuki Easy Start System. If the engine is difficult to start, squeeze the clutch lever and continue pressing the electric starter switch to start up the engine. If the engine fails to start up, the battery will most likely lose power. In this case, charge or change the battery.

STARTING OFF

WARNING

Riding at excessive speeds increases your chances of losing control of the motorcycle, which can result in an accident.

Always ride at a speed that is proper for the terrain, visibility and operating conditions, and your skills and experience.

WARNING

If you remove even one hand or foot from the motorcycle, you can reduce your ability to control the motorcycle. This could cause you to lose your balance and fall off the motorcycle. If you remove a foot from a footrest, your foot or leg may come in contact with the rear wheels. This could injure you or cause an accident.

Always keep both hands on the handlebars and both feet on the footrests of your motorcycle during operation.

WARNING

Sudden side winds, which can occur when being passed by larger vehicles, at tunnel exits or in hilly areas, can cause you to lose control of the motorcycle.

Reduce your speed and be alert to the possibility of sudden side winds.

After moving the side stand to the fully up position, squeeze the clutch lever in and pause momentarily. Engage first gear by depressing the gearshift lever downward. Turn the throttle grip toward you and at the same time release the clutch lever gently and smoothly. As the clutch engages, the motorcycle will start moving forward. To shift to the next higher gear, accelerate gently, then close the throttle and pull the clutch lever in simultaneously. Lift the front end of gearshift lever upward or depress the rear end of gearshift lever to select the next gear and release the clutch lever and open the throttle again. Select the gears in this manner until top gear is reached.

USING THE TRANSMISSION

The transmission is provided to keep the engine operating smoothly in its normal operating speed range. The gear ratios have been carefully chosen to meet the characteristics of the engine. The rider should always select the most suitable gear for the prevailing conditions. When performing a shift change, squeeze the clutch lever completely. Never slip the clutch to control road speed, but rather downshift to allow the engine to run within its normal operational range.

WARNING

Downshifting when engine speed is too high can;

- **cause the rear wheel to skid and lose traction due to increased engine braking, resulting in an accident; or**
- **force the engine to overrev in the lower gear, resulting in engine damage.**

Reduce speed before downshifting.

WARNING

Downshifting while the motorcycle is leaned over in a corner may cause rear wheel skid and loss of control.

Reduce your speed and downshift before entering the corner.

NOTICE

Revvng the engine into the red zone can cause severe engine damage.

Never allow the engine to rev into the red zone in any gear.

NOTICE

Improper gearshift lever operation can damage the transmission.

- **Do not rest your foot on the gearshift lever.**
- **Do not force to shift gears.**

RIDING ON HILLS

- When climbing steep hills, the motorcycle may begin to slow down and show lack of power. At this point you should shift to a lower gear so that the engine will again be operating in its normal power range. Shift rapidly to prevent the motorcycle from losing momentum.
- When descending a long, steep slope, use engine compression to assist the brakes by shifting to a lower gear. Continuous brake application can overheat the brakes and reduce their effectiveness.
- Be careful, however, not to allow the engine to overrev.

STOPPING AND PARKING

Anti-lock Brake System (ABS)

This model is equipped with an Anti-lock Brake System (ABS) designed to help prevent wheel lock up during hard braking or during braking on slippery surfaces while riding in a straight line.

The ABS will operate whenever it senses that the wheels are locking up. You may feel the brake lever and/or the brake pedal pulsate lightly while the ABS is operating.

Even though ABS helps prevent wheel lock-up, you must still be careful when braking in curves. Hard braking while turning could cause wheel skidding and loss of control, whether or not your motorcycle is equipped with ABS. Having ABS does not mean you can take unnecessary risks. ABS will not compensate for poor judgment, incorrect braking techniques, or not slowing down over bad roads or in poor weather conditions.

You must still ride sensibly and alertly.

On regular paved roads, some riders may be able to obtain slightly shorter stopping distances with conventional brake systems than with ABS.

NOTE: In some situations, a motorcycle with ABS may require a longer stopping distance to stop on loose or uneven surfaces than an equivalent motorcycle without ABS.

WARNING

Inexperienced riders tend to underutilize the front brake. This can cause excessive stopping distance and lead to a collision. Using only the front or rear brake can cause skidding and loss of control.

Apply both brakes evenly and at the same time.

 **WARNING**

Braking while turning the motorcycle can be hazardous, whether or not your motorcycle is equipped with ABS. ABS can not control wheel side-slips that occur when you brake hard while turning and the side-slips could cause loss of control.

Slow down sufficiently in a straight line before you begin to turn and avoid other than slight braking while turning.

 **WARNING**

Failure to use good judgment with ABS can be hazardous. ABS cannot make up for bad road conditions, bad judgement, or improper operation of the brakes.

Remember that ABS will not compensate for poor judgment, incorrect braking techniques, or the need to slow down over bad roads or in poor weather conditions. Use good judgment and do not ride faster than conditions will safely allow.

How the ABS Works

ABS works by electronically controlling braking pressure. A computer monitors wheel rotation speed. If the computer detects that a braked wheel has slowed suddenly, indicating a skidding situation, the computer will reduce braking pressure to prevent that wheel from locking up. ABS works automatically, so you do not need any special braking technique. Just apply the front and rear brakes, as forcefully as necessary for the situation, without pumping either one. It is normal for the brake lever/pedal to pulsate while the ABS is operating.

Non-recommended tyres can affect wheel speed and may confuse the computer.

ABS does not work at very low speed, less than about 5 km/h, and does not work with a discharged battery.

Stopping and Parking

1. Twist the throttle grip away from yourself to close the throttle completely.
2. Apply the front and rear brakes evenly and at the same time.
3. Downshift through the gears as road speed decreases.
4. Select neutral with the clutch lever squeezed toward the grip (disengaged position) when the motorcycle is almost completely stopped. The neutral position can be confirmed by observing the neutral indicator light.

WARNING

Inexperienced riders tend to underutilize the front brake. This can cause excessive stopping distance and lead to a collision. Using only the front or rear brake can cause skidding and loss of control.

Apply both brakes evenly and at the same time.

⚠ WARNING

Hard braking while turning may cause wheel skid and loss of control.

Brake before you begin to turn.

⚠ WARNING

Hard braking on wet, loose, rough, or other slippery surfaces can cause wheel skid and loss of control.

Brake lightly and with care on slippery or irregular surfaces.

⚠ WARNING

Following another vehicle too closely can lead to a collision. As vehicle speeds increase, stopping distance increases progressively.

Always maintain a safe stopping distance between you and the vehicle in front of you.

NOTICE

Holding the motorcycle stopped with throttle and clutch lever operation on inclines can damage the motorcycle's clutch.

Use the brakes when stopping the motorcycle on inclines.

5. Park the motorcycle on a firm, flat surface where it will not fall over.

▲ CAUTION

A hot muffler can cause severe burns. The muffler will be hot enough to cause burns for some time after stopping the engine.

Park the motorcycle where pedestrians or children are not likely to touch the muffler.

NOTE: If the motorcycle is to be parked on the side stand on a slight slope, the front end of the motorcycle should face “up” the incline to avoid rolling forward off the side stand. You may leave the motorcycle in 1st gear to help prevent it from rolling off the side stand. Shift to neutral before starting engine.

6. Turn the ignition key to the “OFF” position.
7. Turn the handlebars all the way to the left and lock the steering for security.
8. Remove the ignition key.

NOTE: If an optional anti-theft lock such as a U-shape lock, brake disk lock or chain is used to avoid theft, be sure to remove anti-theft lock before moving the motorcycle.

INSPECTION AND MAINTENANCE

| | |
|--------------------------------------|------|
| MAINTENANCE SCHEDULE | 6-2 |
| TOOLS | 6-6 |
| FRAME COVER REMOVAL (GSX250RL) | 6-7 |
| FAIRING REMOVAL (GSX250FRL) | 6-9 |
| LUBRICATION POINTS | 6-13 |
| BATTERY | 6-15 |
| AIR CLEANER | 6-20 |
| SPARK PLUG | 6-25 |
| FUEL HOSE | 6-29 |
| ENGINE OIL | 6-30 |
| ENGINE IDLE SPEED INSPECTION | 6-36 |
| THROTTLE CABLE ADJUSTMENT | 6-36 |
| CLUTCH | 6-38 |
| DRIVE CHAIN | 6-39 |
| BRAKES | 6-44 |
| TYRES | 6-52 |
| FRONT WHEEL REMOVAL | 6-57 |
| REAR WHEEL REMOVAL | 6-61 |
| LIGHT BULB REPLACEMENT | 6-66 |
| FUSE | 6-69 |
| CATALYTIC CONVERTER | 6-71 |

INSPECTION AND MAINTENANCE

MAINTENANCE SCHEDULE

The chart indicates the intervals between periodic services in kilometers and months. At the end of each interval, be sure to inspect, check, lubricate and service as instructed. If your motorcycle is used under high stress conditions such as continuous full throttle operation, or is operated in a dusty climate, certain services should be performed more often to ensure reliability of the machine as explained in the maintenance section. Your Suzuki dealer can provide you with further guidelines. Steering components, suspensions and wheel components are key items and require very special and careful servicing. For maximum safety we suggest that you have these items inspected and serviced by your authorized Suzuki dealer or a qualified service mechanic.

WARNING

Improper maintenance or failure to perform recommended maintenance can lead to an accident.

Keep your motorcycle in good condition. Ask your Suzuki dealer or a qualified mechanic to perform the maintenance items marked with an asterisk (*). You may perform the unmarked maintenance items by referring to the instructions in this section, if you have mechanical experience. If you are not sure how to do any of the jobs, ask your Suzuki dealer to do the maintenance.

WARNING

Exhaust gas contains carbon monoxide, a dangerous gas that is difficult to detect because it is colourless and odorless. Breathing carbon monoxide can cause death or severe injury.

Never start the engine or let it run indoors or where there is little or no ventilation.

NOTICE

Servicing electric parts with the ignition switch in the “ON” position can damage the electric parts when the electric circuit is shorted.

Turn off the ignition switch before servicing the electric parts to avoid short-circuit damage.

NOTICE













Poorly-made replacement parts can cause your motorcycle to wear more quickly and may shorten its useful life.



When replacing parts on your vehicle, use only genuine Suzuki replacement parts or their equivalent.

NOTE: The MAINTENANCE CHART specifies the minimum requirements for maintenance. If you use your motorcycle under severe conditions, perform maintenance more often than shown in the chart. If you have any questions regarding maintenance intervals, consult your Suzuki dealer or a qualified mechanic.

MAINTENANCE CHART

Interval: This interval should be judged by number of months or odometer reading, whichever comes first.

| Item | Interval | km | 1000 | 4000 | 8000 | 12000 | 16000 | 20000 |
|---|----------|----------------------------------|------|------|------|-------|-------|-------|
| | | Months | 1 | 4 | 8 | 12 | 16 | 24 |
| Air cleaner element ( 6-20) | | - | I | I | R | I | I | |
| | | *Replace every 15000 km | | | | | | |
| *Cylinder head nuts, cylinder nuts, exhaust pipe and muffler bolts and nut | | T | T | T | T | T | T | |
| *Valve clearance | | I | I | I | I | I | I | |
| Sparkplug ( 6-25) | | - | I | I | R | I | I | |
| | | *Replace every 10000 km | | | | | | |
| Fuel Hose ( 6-29) | | - | I | I | I | I | I | |
| | | *Replace every 4 years | | | | | | |
| *Evaporative emission control system | | - | - | I | I | - | I | |
| Engine oil ( 6-30) | | R | R | R | R | R | R | |
| Engine oil filter ( 6-31) | | R | R | R | R | R | R | |
| Throttle cable play ( 6-36) | | I | I | I | I | I | I | |
| Clutch cable play ( 6-38) | | I | I | I | I | I | I | |
| Drive chain ( 6-39) | | I | I | I | I | I | I | |
| | | Clean and lubricate every 1000km | | | | | | |
| *Brakes ( 6-44) | | I | I | I | I | I | I | |
| Brake hose ( 6-45) | | I | I | I | I | I | R | |
| | | *Replace every 2 years | | | | | | |
| Brake fluid ( 6-44) | | I | I | I | I | I | R | |
| | | *Replace every 2 years | | | | | | |
| Tires ( 6-52) | | I | I | I | I | I | I | |

| Item | Interval | 1000 | 4000 | 8000 | 12000 | 16000 | 20000 |
|--|------------------------|------|------|------|-------|-------|-------|
| | km Months | 1 | 4 | 8 | 12 | 16 | 24 |
| *Steering | | | - | | | | |
| *Front fork | | - | | - | | - | |
| *Rear suspension ( 2-36) | | - | - | | - | - | |
| *Chassis nuts and bolts | | T | T | T | T | T | T |
| Lubrication ( 6-13) | Lubricate every 1000km | | | | | | |

NOTE: I= Inspect and clean, adjust, replace or lubricate as necessary;
R= Replace; T= Tighten

TOOLS

Remove the rear seat by referring to the SEAT LOCK AND HELMET HOLDERS section.

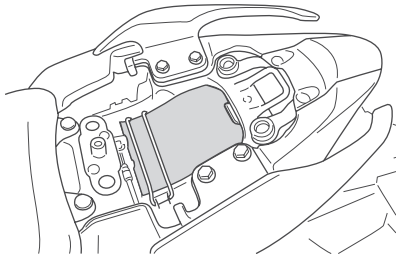

A tool kit is provided with your motorcycle. It is located under the rear seat.

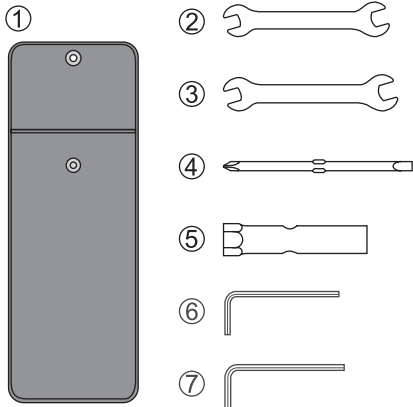

- ① Tool bag
- ② Open end wrench (10 mm × 12 mm)
- ③ Open end wrench (14 mm × 17 mm)
- ④ Screwdriver (+, -)
- ⑤ Socket wrench (16 mm)
- ⑥ Hexagon wrench (4 mm)
- ⑦ Hexagon wrench (5 mm)

FRAME COVER REMOVAL (GSX250RL)

RIGHT FRAME COVER REMOVAL

1. Place the motorcycle on the side stand.
2. Remove the front and rear seat by referring to the SEAT LOCK AND HELMET HOLDERS section.

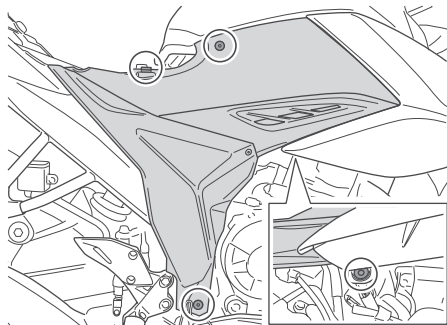

3. Remove the bolts and fastener.

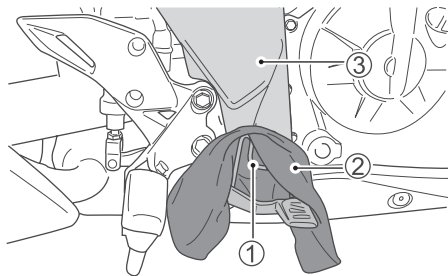

4. Cover the guard bar ① of rear brake pedal with a cloth ②.

NOTICE

When removing the right frame cover, the guard bar ① of rear brake pedal may cause damage the right frame cover ③.

When removing the right frame cover, use a cloth to prevent scratches, and carefully remove the right frame cover.

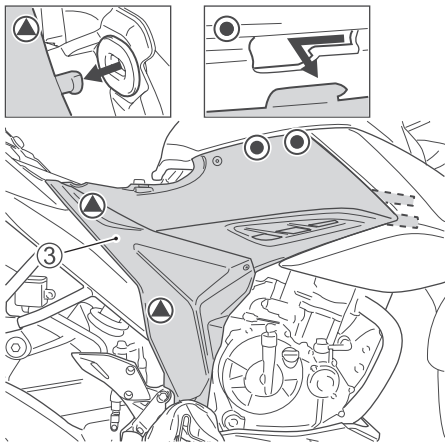

5. Unhook the hooks and remove the frame cover ③.

INSTALLATION

Reinstall the right frame cover in reverse order of removal.

LEFT FRAME COVER REMOVAL

1. Place the motorcycle on the side stand.
2. Remove the front and rear seat by referring to the SEAT LOCK AND HELMET HOLDERS section.

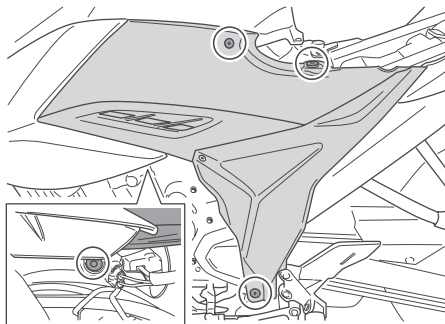

3. Remove the bolts and fastener.

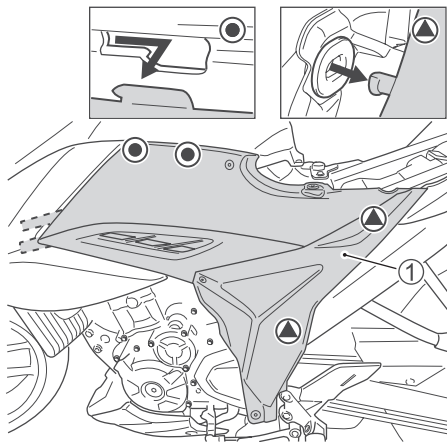

4. Unhook the hooks and remove the frame cover ①.

INSTALLATION

Reinstall the left frame cover in reverse order of removal.

FAIRING REMOVAL (GSX250FRL)

RIGHT FRAME COVER REMOVAL

1. Place the motorcycle on the side stand.
2. Remove the front and rear seat by referring to the SEAT LOCK AND HELMET HOLDERS section.

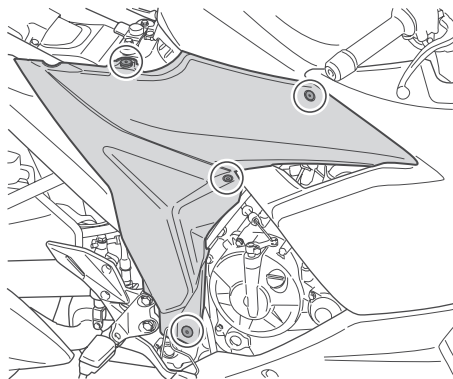

3. Remove the bolts and fastener.

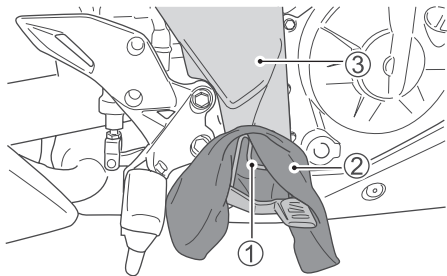

4. Cover the guard bar ① of rear brake pedal with a cloth ②.

NOTICE

When removing the right frame cover, the guard bar ① of rear brake pedal may cause damage the right frame cover ③.

When removing the right frame cover, use a cloth to prevent scratches, and carefully remove the right frame cover.

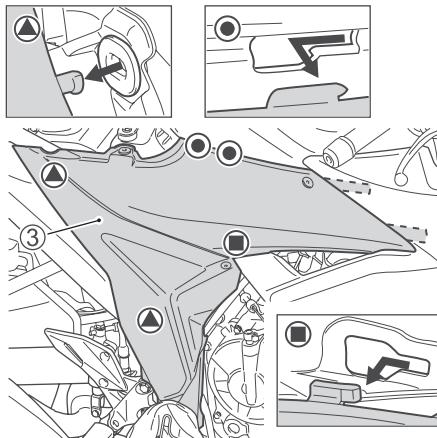

5. Unhook the hooks and remove the frame cover ③.

INSTALLATION

Reinstall the right frame cover in reverse order of removal.

LEFT FRAME COVER REMOVAL

1. Place the motorcycle on the side stand.
2. Remove the front and rear seat by referring to the SEAT LOCK AND HELMET HOLDERS section.

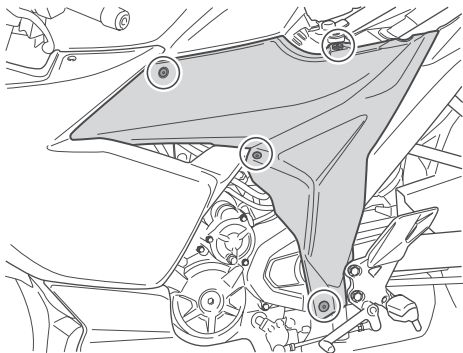

3. Remove the bolts and fastener.

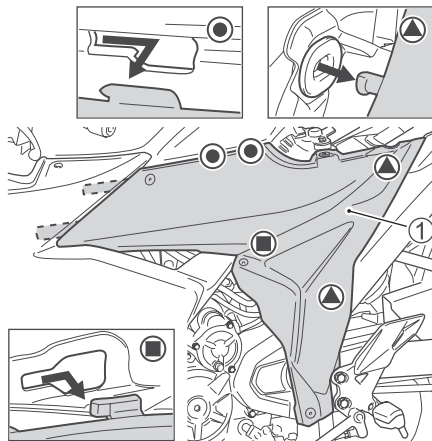

4. Unhook the hooks and remove the frame cover ①.

INSTALLATION

Reinstall the left frame cover in reverse order of removal.

RIGHT SIDE FAIRING REMOVAL

1. Remove the right frame cover by referring to the RIGHT FRAME COVER REMOVAL section.

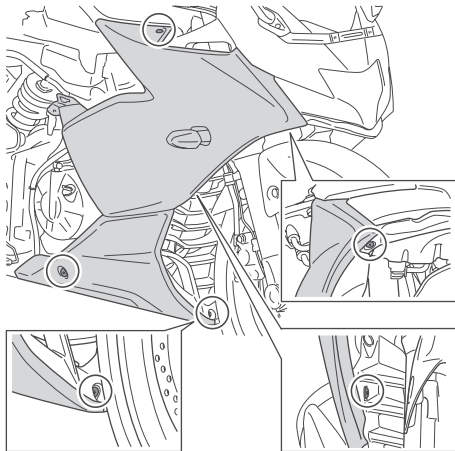

2. Remove the bolts, screws and fastener.

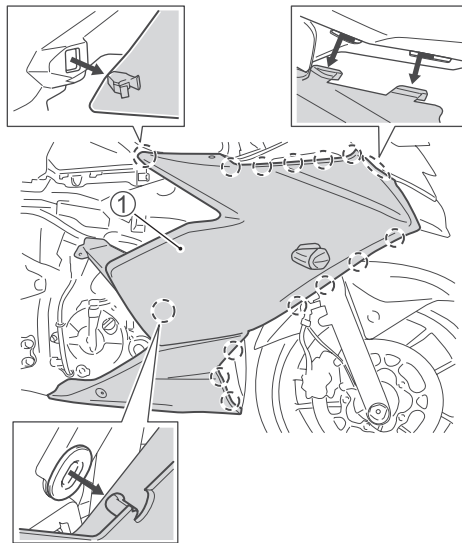

3. Unhook the hooks and remove the right side fairing ①.

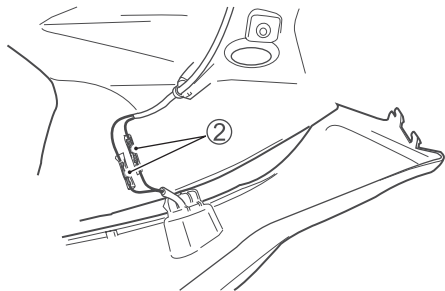

4. Disconnect the front turn signal connectors ②.

INSTALLATION

Reinstall the right side fairing in the reverse order of removal.

LUBRICATION POINTS

Proper lubrication is important for smooth and long life of each working part of your motorcycle and also for safe riding. It is a good practice to lubricate the motorcycle after a long rough ride or after it gets wet in the rain or after washing it. Major lubrication points are indicated as follows.

NOTICE

Lubricating electrical switches can damage the switches.

Do not apply grease and oil to electrical switches.

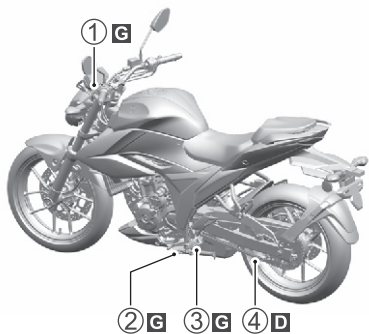

- ①Clutch lever pivot
- ②Side stand pivot and spring hook
- ③Gearshift lever pivot and footrest pivot
- ④Drive chain



- ⑤Brake lever pivot
- ⑥Brake pedal pivot and footrest pivot

- G** Grease
- D** Drive chain lubricant

BATTERY

The battery is a sealed type battery and requires no maintenance of fluid level and gravity. Have your dealer check the charging condition of the battery periodically.

NOTE:

- For charging a sealed type battery, use a battery charger applicable to a sealed type battery.
- If you cannot charge the battery, consult your authorized Suzuki dealer.

WARNING

Battery posts, terminals, and related accessories contain lead and lead compounds. Lead is harmful to your health if it gets into your blood stream.

Wash hands after handling any parts containing lead.

WARNING

Diluted sulfuric acid from the battery can cause blindness or severe burns.

When working near the battery, use proper eye protection and gloves. Flush eyes or body with ample water and get medical care immediately if you suffer injury. Keep batteries out of reach of children.

WARNING

Batteries produce flammable hydrogen gas which can explode if exposed to flames or sparks.

Keep flames and sparks away from the battery. Never smoke when working near the battery.

 **WARNING**

Wiping the battery with a dry cloth can cause a static electricity spark, which can start a fire.

Wipe the battery with a damp cloth to avoid static electricity build up.

NOTICE

Exceeding the maximum charging rate for the battery can shorten its life.

Never exceed the maximum charging rate for the battery.

BATTERY REMOVAL

To remove the battery, follow the procedure below:

1. Place the motorcycle on the side stand.
2. Remove the front and rear seat by referring to the SEAT LOCK AND HELMET HOLDERS section.
3. Remove the left frame cover by referring to the FRAME COVER REMOVAL (GSX250RL) and FAIRING REMOVAL (GSX250FRL) section.

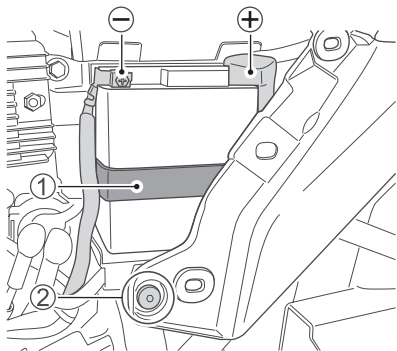

4. Disconnect the negative (-) terminal first, then disconnect the positive (+) terminal.
5. Remove the battery band (1) and bolt (2).

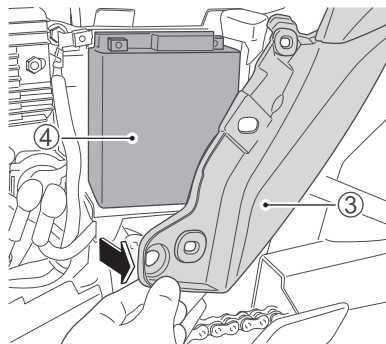

6. Pull the rear frame cover (3) and pull out the battery (4).

To install the battery:

1. Install the battery in the reverse order of removal.
2. Connect the battery terminals securely.

WARNING

Batteries contain toxic substances including sulfuric acid and lead. They could have potential negative consequences for the environment and human health.

A used battery must be disposed or recycled according to the local law and must not be discarded with ordinary household waste. Make sure not to tip over the battery when you remove it from the motorcycle. Otherwise, sulfuric acid could run out and you might get injury.

NOTICE

Reversing the battery lead wires can damage the charging system and the battery.

Always attach the red lead to the (+) positive terminal and the black (or black with white tracer) lead to the (-) negative terminal.

NOTE:

- Select the same type MF battery when replacing the battery.
- Recharge the battery once a month if the motorcycle is not used for a long time.

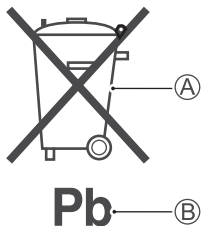

The crossed-out wheeled bin symbol (A) located on the battery label indicates that a used battery should be collected separately from ordinary household waste.

The chemical symbol of “Pb” (B) indicates the battery contains more than 0.004% lead.

By ensuring the used battery is disposed of or recycled correctly, you will help prevent potential negative consequences for the environment and human health, which could otherwise be caused by inappropriate waste handling of the battery. The recycling of materials will help to conserve natural resources. For more detailed information about disposing or recycling of the used battery, consult your Suzuki dealer.

AIR CLEANER

The air cleaner is located under the front seat. If the elements have become clogged with dust, intake resistance will increase with a resultant decrease in power output and an increase in fuel consumption. If you use your motorcycle under normal low-stress conditions, you should service the air cleaner at the intervals specified. If you ride in dusty, wet or muddy conditions, you will need to inspect the air cleaner element much more frequently. Use the following procedure to remove the element and inspect it.

WARNING

Operating the engine without the air cleaner element in place can be hazardous. A flame can spit back from the engine to the air intake box without the air cleaner element to stop it. Severe engine damage can also occur if dirt enters the engine due to running the engine without the air cleaner element.

Never run the engine without the air cleaner element in place.

NOTICE

Failure to inspect the air cleaner element frequently if the vehicle is used in dusty, wet, or muddy conditions can damage your motorcycle. The air cleaner element can become clogged under these conditions, and engine damage may result.

Always inspect the air cleaner element after riding in severe conditions. Clean or replace the element as necessary. If water gets in the air cleaner case, immediately clean the element and the inside of the case.

AIR CLEANER REMOVAL AND CLEANING

Follow the procedure below to remove the air cleaner element.

1. Place the motorcycle on the side stand.
2. Remove the front and rear seat by referring to the SEAT LOCK AND HELMET HOLDERS section.
3. Remove the left frame cover by referring to the FRAME COVER REMOVAL (GSX250RL) and FAIRING REMOVAL (GSX250FRL) section.

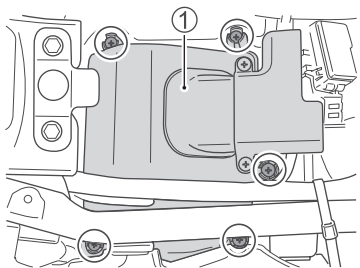

4. Remove the screws. Remove the air cleaner cap ①.

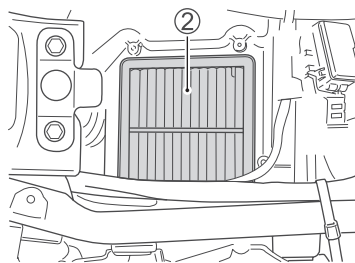

5. Remove the air cleaner element ②.

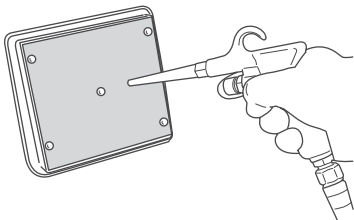

6. Carefully use an air hose to blow the dust from the air cleaner element.

NOTE: Always apply air pressure to the mesh side of the air cleaner element only. If you apply air pressure to the fabric side, dirt will be forced into the pores of the element, restricting the air flow through the element.

7. Reinstall the cleaned element or new air cleaner element in reverse order of removal. Be absolutely sure that the element is securely in position and is sealing properly.

NOTICE

A torn air cleaner element will allow dirt to enter the engine and can damage the engine.

Replace the air cleaner element with a new one if it is torn. Carefully examine the air cleaner element for tears during cleaning.

NOTICE

Failure to position the air cleaner element properly can allow dirt to bypass the air cleaner element. This will cause engine damage.

Be sure to properly install the air cleaner element.

NOTE: Be careful not to spray water on the air cleaner box when cleaning the motorcycle.

Air Cleaner Drain Plug

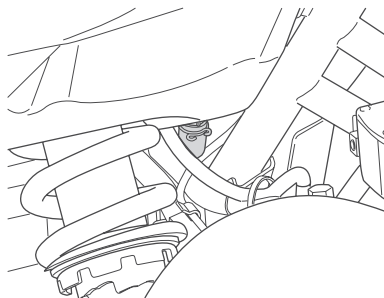

Remove the plug and drain water and oil at the periodic maintenance interval.

SPARK PLUG

REMOVAL

To remove the spark plug, follow the procedure below:

1. Remove the front and rear seat by referring to the SEAT LOCK AND HELMET HOLDERS section. (GSX250FRL)
2. Remove the left frame cover by referring to the FAIRING REMOVAL (GSX250FRL) section.

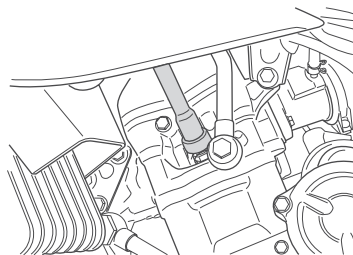

GSX250RL

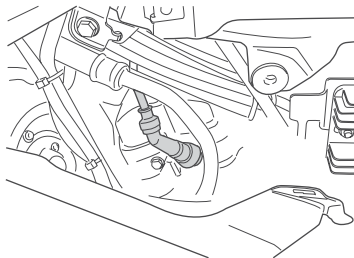

GSX250FRL

3. Pull off the spark plug cap.

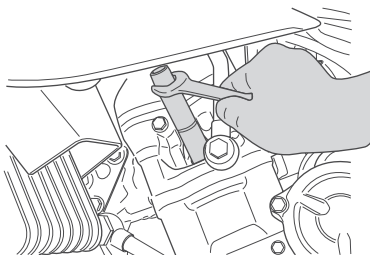

GSX250RL

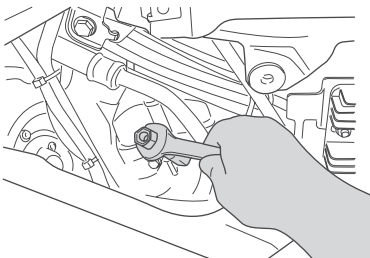

GSX250FRL

4. Remove the spark plug with a spark plug wrench.

NOTICE

Dirt can damage the moving engine parts your motorcycle if it enters an open spark plug hole.

Cover the spark plug hole while the spark plug is out of the hole.

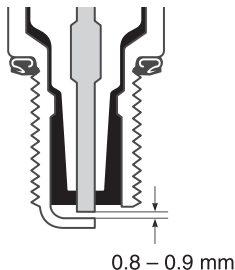

Adjust the spark plug gap to 0.8 – 0.9 mm by using a spark plug gap thickness gauge. The spark plug should be replaced periodically.

Whenever removing the carbon deposits, be sure to observe the operational colour of each spark plug's porcelain tip. This colour tells you whether or not the standard spark plug is suitable for your type of usage. A normally- operating spark plug should be very light brown in colour. If the spark plug is very white or glazed appearing, it has been operating much too hot. This spark plug should be replaced with the colder plug.

NOTICE

An improper spark plug may have an incorrect fit or inappropriate heat range for your engine. This may cause severe engine damage which may not be covered under warranty.

Use one of the spark plugs listed or equivalent. Consult your Suzuki dealer if you are not sure which spark plug is correct for your type of usage.

Plug Replacement Guide

| NGK | REMARKS |
|--------|----------|
| MR8E-9 | Standard |

NOTE: This motorcycle uses resistor-type spark plug to avoid jamming electronic parts. Improper spark plug selection may cause electronic interference with your motorcycle ignition system, resulting in motorcycle performance problems. Use recommended spark plugs.

INSTALLATION

NOTICE

Improper installation of the spark plug can damage your motorcycle. An overly-tight or cross-threaded spark plug will damage the aluminum threads of the cylinder head.

Carefully turn the spark plug by hand into the threads. If the spark plug is new, tighten it with a wrench about 1/2 turn past finger tight. If you are reusing the old spark plug, tighten it with a wrench about 1/8 turn past finger tight.

NOTICE

Dirt can damage the moving engine parts your motorcycle if it enters an open spark plug hole.

Cover the spark plug hole while the spark plug is out of the hole.

FUEL HOSE

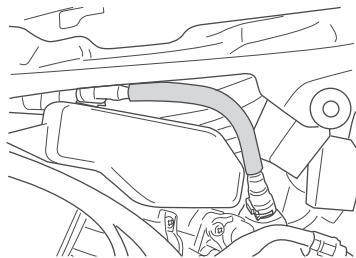

Remove the right frame cover by referring to the **FRAME COVER REMOVAL (GSX250RL)** and **FAIRING REMOVAL (GSX250FRL)** section. Inspect the fuel hose for damage and fuel leakage. If any defects are found, the fuel hose must be replaced.

ENGINE OIL

Long engine life depends much on the selection of a quality oil and the periodic changing of the engine oil. Daily engine oil level checks and periodic changes are two of the most important maintenance to be performed.

ENGINE OIL LEVEL CHECK

Follow the procedure below to inspect the engine oil level.

1. Place the motorcycle on level ground on the side stand.
2. Start the engine and run it for three minutes.
3. Stop the engine and wait three minutes.

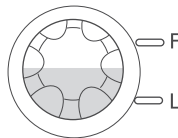

4. Release the side stand. Hold the motorcycle vertically and inspect the engine oil level through the engine oil level inspection window on the right side of the engine.

NOTICE

Operating the motorcycle with too little or too much oil can damage the engine.

Place the motorcycle on level ground. Check the oil level with the engine oil inspection window before each use of the vehicle. Be sure the engine oil level is always above the “L” (low) line and not higher than the “F” (full) line.

ENGINE OIL AND FILTER CHANGE

Change the engine oil and engine oil filter at the scheduled time. The engine oil should be changed when the engine is warm so that the engine oil will drain thoroughly from the engine. The procedure is as follows:

1. Place the motorcycle on the side stand.

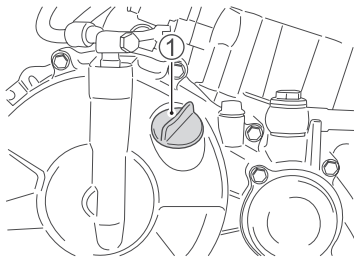

2. Remove the engine oil filler cap ①.

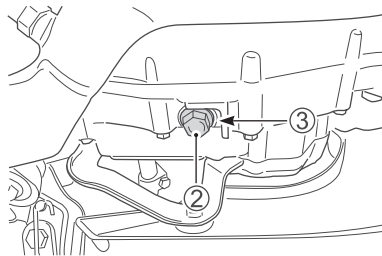

3. Place a drain pan under the drain plug ②.
4. Remove the drain plug ② and gasket ③ with a wrench and drain out the engine oil while holding the motorcycle vertically.

▲ CAUTION

Hot engine oil and exhaust pipes can burn you.

Wait until the oil drain plug and exhaust pipes are cool enough to touch with bare hands before draining oil.

WARNING

Children and pets may be harmed by swallowing new or used oil. Repeated, prolonged contact with used engine oil may cause skin cancer. Brief contact with oil may irritate skin.

Keep new and used oil and used oil filters away from children and pets. To minimize your exposure to used oil, wear a long-sleeve shirt and moisture-proof gloves (such as dishwashing gloves) when changing oil. If oil contacts your skin, wash thoroughly with soap and water. Launder any clothing or rags if wet with oil. Recycle or properly dispose of used oil and filters.

NOTICE

Turning the engine while draining the engine oil will cause oil film shortage and adversely affect the engine.

Do not use the electric starter switch during engine oil replacement work.

NOTE:

- Recycle or properly dispose of used oil.
 - Before starting the work, check that there is not any dust, mud, or foreign object inside the oil jug or on the oil filter mounting surface.
5. Replace the gasket ③ with a new one. Reinstall the drain plug ② and gasket ③. Tighten the plug securely with a wrench.

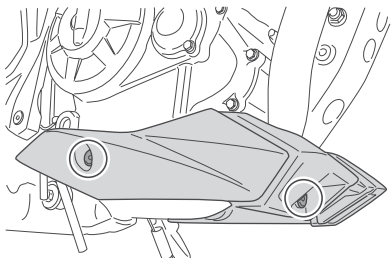

GSX250RL

6. Remove the under cowling by removing the right and left bolts. (GSX250RL)
Remove the right side fairing by referring to the FAIRING REMOVAL (GSX250FRL) section.

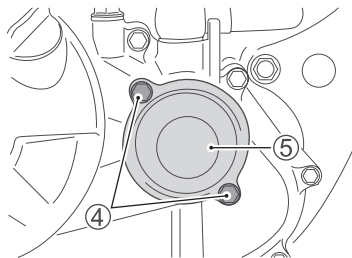

7. Remove the two bolts ④ holding the filter cap ⑤ in place.

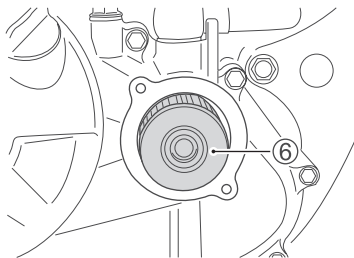

8. Replace the engine oil filter ⑥ with a new one.

NOTICE

Failure to use an oil filter with the correct design can damage your motorcycle's engine.

Be sure to use a genuine Suzuki oil filter or an equivalent one designed for your motorcycle.

NOTICE

Failure to insert the new element correctly can damage the engine. No oil flow will result if the element is inserted backwards.

Insert the open end of the new oil filter element into the engine.

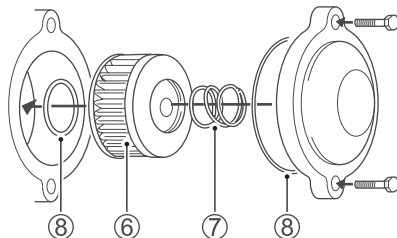

9. Before replacing the engine oil filter cover, be sure to check that the engine oil filter spring ⑦ and the "O" rings ⑧ are installed correctly.

NOTE: Use new “O” rings each time the engine oil filter element is replaced.

10. Replace the oil filter cover and tighten the bolts securely but do not overtighten them.
11. Replace the gasket with a new one. Reinstall the drain plug and gasket. Tighten the plug securely with a torque wrench. Pour fresh oil through the filler hole. Approximately 1200 ml of oil will be required.

Drain plug tightening torque:
21 N·m (2.1 kgf-m)

NOTE: Approximately 1180 ml of oil will be required when changing oil only without replacing the oil filter.

NOTICE

Engine damage may occur if you use oil that does not meet Suzuki's specifications.

Use the oil specified in the FUEL AND ENGINE OIL RECOMMENDATION section.

12. Tighten the oil filler cap.
13. Start the engine and allow it to idle for three minutes.
14. Check the oil level according to Oil Level Check procedure.

NOTE: Check to see that no oil is leaking from the oil filter cover.

ENGINE IDLE SPEED INSPECTION

Inspect the engine idle speed. The engine idle speed should be 1400 – 1600 r/min when the engine is warm.

NOTE: If the engine idle speed is not within the specified range, ask your Suzuki dealer or a qualified mechanic to inspect and repair the motorcycle.

THROTTLE CABLE ADJUSTMENT

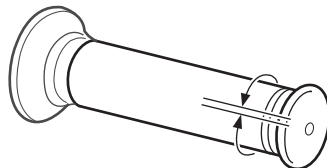
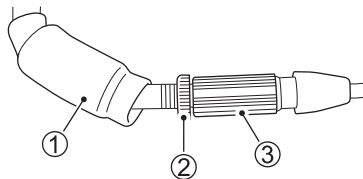

2.0 – 4.0 mm

To adjust the cable play:

1. Remove the boot ①.
2. Loosen the lock nut ②.
3. Turn the adjuster ③ so that the throttle grip has 2.0 – 4.0 mm play.
4. Tighten the lock nut ②.
5. Replace the boot ①.

WARNING

Inadequate throttle cable play can cause engine speed to rise suddenly when you turn the handlebars. This can lead to loss of control and an accident.

Adjust the throttle cable play so that engine idle speed does not rise due to handlebar movement.

THROTTLE CABLE BOOTS

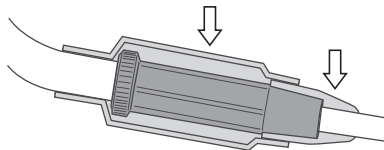

The throttle cable has boots. Check that the boots are fit securely. Do not apply water directly to the boots when washing. Wipe off dirt from the boots with a wet cloth when the boots are dirty.

CLUTCH

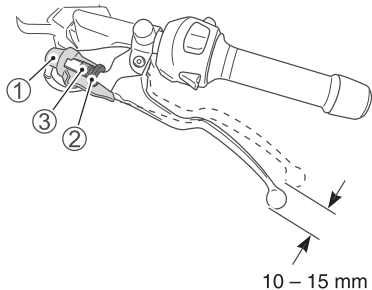

The play of the clutch lever should be 10 – 15 mm as measured at the clutch lever end. If you find the play of the clutch incorrect, adjust it in the following way.

Minor Adjustment

1. Slide the boot ①.
2. Loosen the clutch cable adjuster lock nut ②.
3. Turn the clutch cable adjuster ③ to provide the specified play.
4. Tighten the lock nut ②.
5. Reinstall the boot ①.

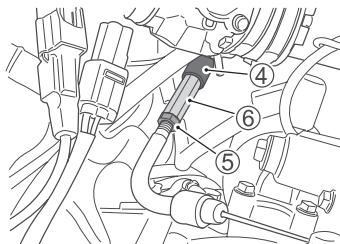

Major Adjustment

1. Slide the boot ④.
2. Loosen the clutch cable adjuster lock nut ⑤.
3. Turn the clutch cable adjuster ⑥ to provide the specified play.
4. Tighten the lock nut ⑤.
5. Reinstall the boot ④.

NOTE: Any maintenance of the clutch other than the clutch cable play adjustment should be performed by your Suzuki dealer.

DRIVE CHAIN

This motorcycle has an endless drive chain constructed from special materials. It does not use a master link. The drive chain has special O-rings that permanently keep grease inside. We recommend that you take your motorcycle to an authorized Suzuki dealer if the drive chain needs to be replaced.

WARNING

Riding with the chain in poor condition or improperly adjusted can lead to an accident.

Inspect, adjust, and maintain the chain properly before each ride, according to the instructions in this section.

The condition and adjustment of the drive chain should be checked each day before you ride. Always follow the guidelines below for inspecting and servicing the chain.

Inspecting the Drive Chain

When inspecting the chain, look for the following:

- Loose pins
- Damaged rollers
- Dry or rusted links
- Kinked or binding links
- Excessive wear
- Improper chain adjustment

If you find anything wrong with the drive chain condition or adjustment, correct the problem if you know how. If necessary, consult your authorized Suzuki dealer or a qualified mechanic.

Damage to the drive chain means that the sprockets may also be damaged. Inspect the sprockets for the following:

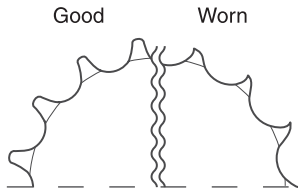

- Excessively worn teeth
- Broken or damaged teeth
- Loose sprocket mounting nuts

If you find any of these problems with your sprocket, consult your Suzuki dealer or a qualified mechanic.

NOTE: The two sprockets should be inspected for wear when a new chain is installed and replace them if necessary.

WARNING

Improperly installing a replacement chain, or using a joint-clip type chain, can be hazardous. An incompletely riveted master link, or a joint-clip type master link, may come apart and cause an accident or severe engine damage.

Do not use a joint-clip type chain. Chain replacement requires a special riveting tool and a high-quality, non-joint-clip type chain. Ask an authorized Suzuki dealer or a qualified mechanic to perform this work.

DRIVE CHAIN CLEANING AND OILING

1. Remove dirt and dust from the drive chain. Be careful not to damage the seal ring.
2. Clean the drive chain with a sealed drive chain cleaner, or water and neutral detergent.

NOTICE

Cleaning the drive chain improperly can damage seal rings and ruin the drive chain.

- **Do not use a volatile solvent such as paint thinner, kerosene and gasoline.**
- **Do not use a high pressure cleaner to clean the drive chain.**
- **Do not use a wire brush to clean the drive chain.**

3. Use a soft brush to clean the drive chain. Be careful not to damage the seal ring even though using a soft brush.
4. Wipe off water and neutral detergent.
5. Lubricate with a motorcycle sealed drive chain lubricant or high viscosity oil (#80 – 90).

NOTICE

Some drive chain lubricant contains solvents and additives which could damage the seal rings in the drive chain.

Use sealed drive chain lubricant which is specifically intended for use with sealed drive chains.

6. Lubricate both front and back plates of the drive chain.
7. Wipe off excess lubricant after lubricating all around the drive chain.

DRIVE CHAIN ADJUSTMENT

Check the drive chain slack at the middle between the two sprockets. The chain may require more frequent adjustment than periodic maintenance interval depending on your riding conditions.

WARNING

Too much chain slack can cause the chain to come off the sprockets, resulting in an accident or serious damage to the motorcycle.

Inspect and adjust the drive chain slack before each use.

To adjust the drive chain, follow these directions:

CAUTION

A hot muffler can burn you. The muffler will be hot enough to burn you for some time after stopping the engine.

Wait until the muffler cools before adjusting the drive chain.

1. Place the motorcycle on the side stand.

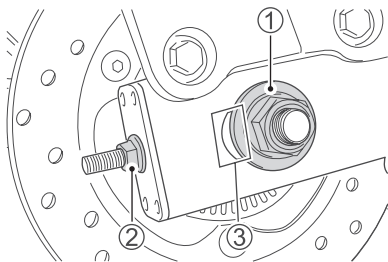

Right

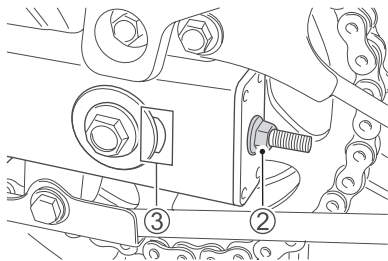

Left

2. Loosen the rear axle nut ①.
3. Loosen the right and left chain adjuster nuts ②.

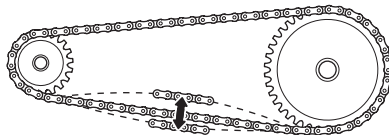

20 - 30 mm

4. Adjust the slack in the drive chain by turning the right and left chain adjuster nuts ②. At the same time that the chain is being adjusted, the rear sprocket must be kept in perfect alignment with the front sprocket. To assist you in performing this procedure, there are reference marks ③ on the swingarm and notches on each chain adjuster which are to be aligned with each other and to be used as a reference from one side to the other.

5. Tighten the axle nut ① securely after aligning and adjusting the slack in the drive chain to 20 – 30 mm.
6. Tighten the right and left chain adjuster nuts ② securely.
7. Recheck the chain slack after tightening and readjust if necessary.

Rear axle nut tightening torque:
65 N·m (6.5 kgf·m)

BRAKES

Properly operating brake systems is vital to safe riding. Be sure to perform the brake inspection as scheduled. The brakes should be inspected at periodic inspection by your authorized Suzuki dealer.

BRAKE SYSTEM

WARNING

Failure to properly inspect and maintain your motorcycle's brake systems can increase your chance of having an accident.

Be sure to inspect the brakes before each use according to the **INSPECTION BEFORE RIDING** section. Always maintain your brakes according to the **MAINTENANCE SCHEDULE**.

Inspect your brake system for the following items daily:

- Inspect the fluid level in the reservoirs.
- Inspect the brake system for signs of fluid leakage.
- Inspect the brake hose for leakage or a cracked appearance.
- The brake lever and pedal should have the proper stroke and be firm at all times.
- Check the wear of the disk brake pads.

BRAKE HOSE INSPECTION

Inspect the brake hoses and hose joints for cracks, damage or brake fluid leakage. If any defects are found, ask your Suzuki dealer to replace the brake hose with a new one.

BRAKE FLUID

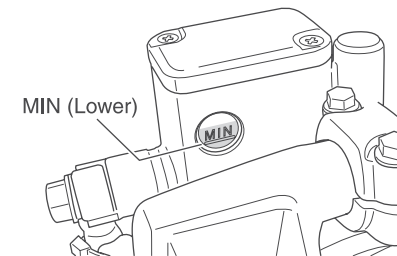

FRONT

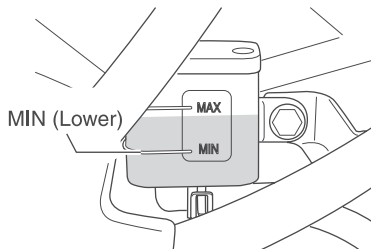

REAR

Check the brake fluid level in both the front and rear brake fluid reservoirs. If the level in either reservoir is below the MIN (lower) line, inspect for brake pad wear and leaks.

WARNING

Brake fluid will gradually absorb moisture through the brake hoses. Brake fluid with high water content lowers the boiling point and can cause brake system (including ABS) malfunction due to corrosion of brake components. Boiling brake fluid or brake system (including ABS) malfunction could result in an accident.

Replace the brake fluid every two years to maintain braking performance.

WARNING

The use of any fluid except DOT3 (front) or DOT4 (front and rear) brake fluid from a sealed container can damage the brake system and lead to an accident.

Clean filler cap before removing. Use only DOT3 (front) or DOT4 (front and rear) brake fluid from a sealed container. Never use or mix with different types of brake fluid.

WARNING

Brake fluid is harmful or fatal if swallowed, and harmful if it comes in contact with skin or eyes. Solution can be poisonous to animals.

If brake fluid is swallowed, do not induce vomiting. Immediately contact a poison control centre or a physician. If brake fluid gets in eyes, flush eyes with water and seek medical attention. Wash thoroughly after handling. Keep out of the reach of children and animals.

NOTICE

Spilled brake fluid can damage painted surfaces and plastic parts.

Be careful not to spill any fluid when filling the brake fluid reservoir. Wipe spilled fluid up immediately.

BRAKE PADS

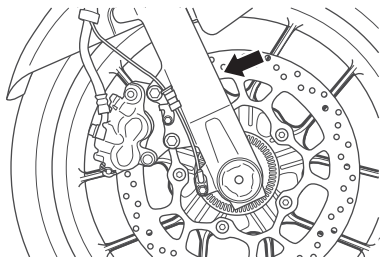

FRONT

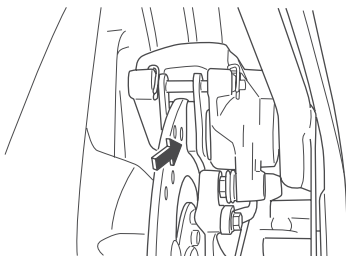

REAR

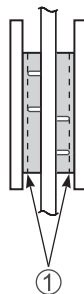

FRONT

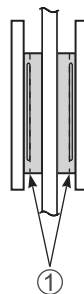

REAR

Inspect the front and rear brake pads by noting whether or not the friction pads are worn down to the grooved wear limit line ①. If a front or rear pad is worn to the grooved wear limit line, it must be replaced with a new one by your authorized Suzuki dealer or a qualified service mechanic.

NOTE: After replacing the brake pads, the brake lever or pedal must be pumped several times. This will extend the pads to their proper position.

WARNING

Failure to inspect and maintain the brake pads and replace them when recommended can increase your chance of having an accident.

If you need to replace brake pads, have your Suzuki dealer do this work. Inspect and maintain the brake pads as recommended.

WARNING

If you ride this motorcycle after brake system repair or brake pad replacement without pumping the brake lever/pedal, you may get poor braking performance which could result in an accident.

After brake system repair or brake pad replacement, pump the brake lever/pedal several times until brake pads are pressed against the brake disks and proper lever stroke and firm feel are restored.

NOTE: Do not squeeze/depress the brake lever/pedal when the pads are not in their positions. It is difficult to push the pistons back and brake fluid leakage may result.

WARNING

Replacing only one of the two brake pads can result in uneven braking action and can increase your chance of having an accident.

Always replace both pads together.

REAR BRAKE PEDAL ADJUSTMENT

The rear brake pedal position must be properly adjusted at all times or the disk brake pads will rub against the disk causing damage to the pads and to the disk surface. Adjust the brake pedal position in the following manner:

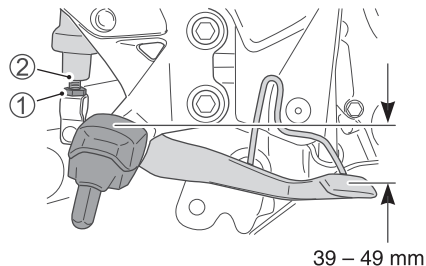

1. Loosen the lock nut ①, and rotate the push rod ② to locate the pedal 39 – 49 mm below the top face of the footrest.
2. Retighten the lock nut ① to secure the push rod ② in the proper position.

NOTICE

An incorrectly adjusted brake pedal may force brake pads to continuously rub against the disk, causing damage to the pads and disk.

Follow the steps in this section to adjust the brake pedal properly.

REAR BRAKE LIGHT SWITCH

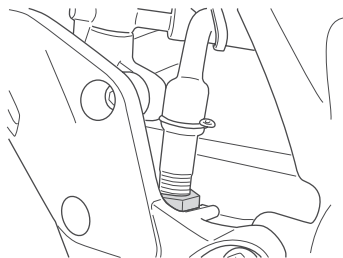

To adjust the brake light switch, hold the switch body and turn the adjuster so that the brake light will come on just before a pressure rise is felt when the brake pedal is depressed.

TYRES

WARNING

The tyres on your motorcycle form the crucial link between your motorcycle and the road. Failure to take the precautions below may result in an accident due to tyre failure.

- Check tyre condition and pressure before each ride, and adjust pressure if necessary.
- Avoid overloading your motorcycle.
- Replace a tyre when worn to the specified limit, or if you find damage such as cuts or cracks.
- Always use the size and type of tyres specified in this owner's manual.
- Balance the wheel after tyre installation.
- Read this section of the owner's manual carefully.

WARNING

Failure to perform break-in of the tyres could cause tyre slip and loss of control, which could result in an accident.

Use extra care when riding on new tyres. Perform proper break-in of the tyres referring to the **BREAK-IN** section of this manual and avoid hard acceleration, hard cornering, and hard braking for the first 160 km.

TYRE PRESSURE AND LOADING

Proper tyre pressure and proper tyre loading are important factors. Overloading your tyres can lead to tyre failure and loss of motorcycle control.

Check tyre pressure each day before you ride, and be sure the pressure is correct for the vehicle load according to the table below. Tyre pressure should only be checked and adjusted before riding, since riding will heat up the tyres and lead to higher inflation pressure readings.

Under-inflated tyres make smooth cornering difficult, and can result in rapid tyre wear. Over-inflated tyres cause a smaller amount of tyre to be in contact with the road, which can contribute to skidding and loss of control.

Cold Tyre Inflation Pressure

| LOAD TYRE | SOLO RIDING | DUAL RIDING |
|--------------|---|---|
| FRONT | 200 kPa 2.00 kgf/cm ² 29 psi | 200 kPa 2.00 kgf/cm ² 29 psi |
| REAR | 225 kPa 2.25 kgf/cm ² 33 psi | 225 kPa 2.25 kgf/cm ² 33 psi |

NOTE: When you detect drops in tyre pressure, check the tyre for nails or other punctures, or a damaged wheel rim. Tubeless tyres sometimes lose pressure gradually when punctured.

TYRE CONDITION AND TYPE

Proper tyre condition and proper tyre type affect motorcycle performance. Cuts or cracks in the tyres can lead to tyre failure and loss of motorcycle control. Worn tyres are susceptible to puncture failures and subsequent loss of motorcycle control. Tyre wear also affects the tyre profile, changing motorcycle handling characteristics.

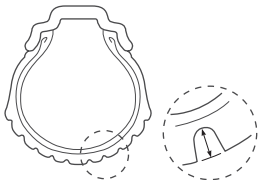

Check the condition of your tyres each day before you ride. Replace tyres if tyres show visual evidence of damage, such as cracks or cuts, or if tread depth is less than 1.6 mm front, 2.0 mm rear.

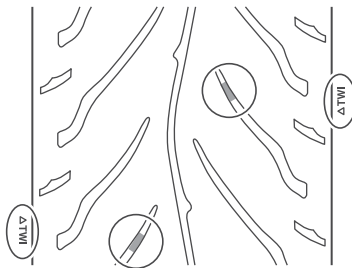

NOTE: The “T.W.I. Δ” mark indicates the place where the wear bars are molded into the tyre. When the wear bars contact the road, it indicates that the tyre wear limit has been reached.

When you replace a tyre, be sure to replace it with a tyre of the size and type listed below. If you use a different size or type of tyre, motorcycle handling may be adversely affected, possibly resulting in loss of motorcycle control.

| | FRONT | REAR |
|------|-------------------|-------------------|
| SIZE | 110/70R17 M/C 54S | 150/60R17 M/C 66S |
| TYPE | MRF REVZ-FC2 | MRF REVZ-C2 |

Always balance the wheel after repairing a puncture or replacing the tyre. Proper wheel balance is important to avoid variable wheel-to-road contact, and to avoid uneven tyre wear.

WARNING

An improperly repaired, installed, or balanced tyre can cause loss of control and an accident, or can wear out sooner.

- **Ask your Suzuki dealer or a qualified mechanic to perform tyre repair, replacement, and balancing because proper tools and experience are required.**
- **Install tyres according to the rotation direction shown by the mark on the sidewall of each tyre.**

WARNING

Failure to follow the instructions below for tubeless tyres may result in an accident due to tyre failure. Tubeless tyres require different service procedures than tube tyres.

- Tubeless tyres require an air-tight seal between the tyre bead and wheel rim. Special tyre irons and rim protectors or a specialized tyre mounting machine must be used for removing and installing tyres to prevent tyre or rim damage which could result in an air leak.
- Repair punctures in tubeless tyres by removing the tyre and applying an internal patch.
- Do not use an external repair plug to repair a puncture since the plug may work loose as a result of the cornering forces experienced by a motorcycle tyre.

- After repairing a tyre, do not exceed 80 km/h for the first 24 hours, and do not exceed 130 km/h thereafter. This is to avoid excessive heat build-up which could result in a tyre repair failure and tyre deflation.
- Replace the tyre if it is punctured in the sidewall area, or if a puncture in the tread area is larger than 6 mm. These punctures cannot be repaired adequately.

FRONT WHEEL REMOVAL

1. Place the motorcycle on the side stand.

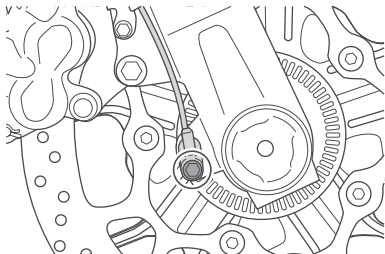

2. Remove the front wheel speed sensor by removing the mounting bolt.

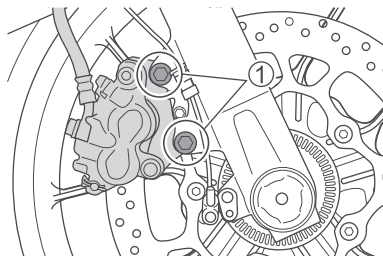

3. Remove the brake caliper from the front forks by removing mounting bolts ①.

NOTE: Never squeeze the front brake lever with the caliper removed. It is very difficult to force the pads back into the caliper assembly and brake fluid leakage may result.

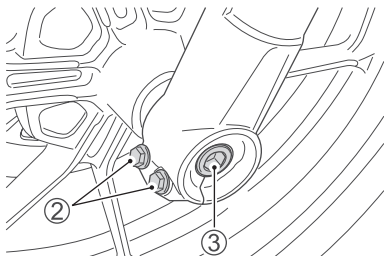

4. Loosen the axle holder bolts ②.
5. Loosen the axle shaft ③ temporarily.

NOTE: A special tool is necessary to loosen the axle shaft ③. The special tool is available at your Suzuki dealer.

6. Place an accessory service stand or equivalent under the swingarm to help stabilize the rear end.
7. Carefully position a jack under the engine and raise the jack until the front wheel is slightly off the ground.

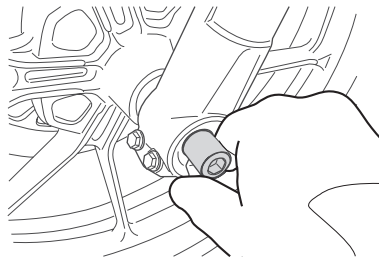

8. Turn the axle shaft counterclockwise and draw it out.

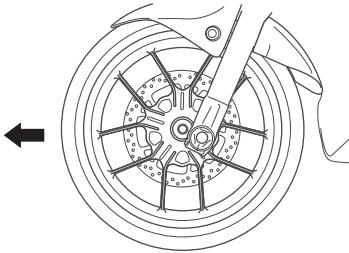

9. Slide the front wheel forward.
10. To reinstall the wheel assembly, reverse the sequence described above.
11. After installing the wheel, apply the front brake several times to restore the proper lever stroke.

⚠ WARNING

Failure to extend brake pads after installing the wheel can cause poor braking performance and may result in an accident.

Before riding, “pump” the brake lever repeatedly until the brake pads are pressed against the brake disks and proper lever stroke and firm feel are restored. Also check that the wheel rotates freely.

WARNING

Installing the front wheel in the reverse direction can be hazardous. The tyre for this motorcycle is directional. Therefore, the motorcycle may have unusual handling if the wheel is installed incorrectly.

Install the front wheel so that the tyre rotates in the specified direction, as indicated by the arrow on the sidewall of the tyre.

WARNING

If the axle shaft and axle holder bolt are not properly tightened, the wheel can come off, causing an accident.

Be sure to tighten the axle shaft and bolt to the specified torque. If you do not have a torque wrench or do not know how to use one, ask your authorized Suzuki dealer to check the axle shaft and bolt.

Front axle shaft tightening torque:
65 N·m (6.5 kgf·m)

Front axle holder bolt tightening torque:
23 N·m (2.3 kgf·m)

Front brake caliper mounting bolt
tightening torque:
26 N·m (2.6 kgf·m)

REAR WHEEL REMOVAL

CAUTION

A hot muffler can burn you.

Wait until the muffler cools before removing the axle nut.

NOTICE

Removing the rear wheel without use of an accessory stand can result in your motorcycle falling over and being damaged.

Do not attempt roadside removal of the rear wheel. Only remove the rear wheel at a properly equipped servicing facility using an accessory service stand.

1. Place the motorcycle on the side stand.

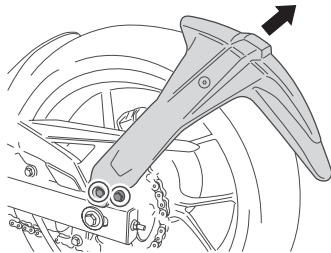
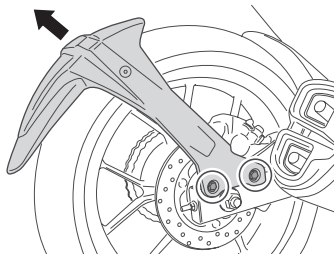

2. Remove the rear fender lower assembly by removing the right and left bolts.

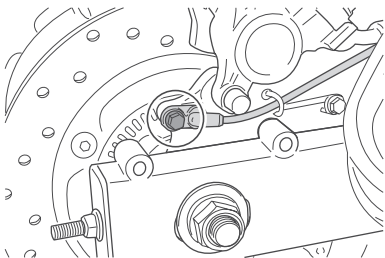

3. Remove the rear wheel speed sensor by removing the mounting bolt.

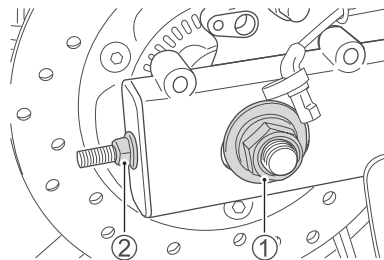

4. Remove the axle nut ①.
5. Place an accessory service stand or equivalent under the swingarm to lift the rear wheel slightly off the ground.
6. Loosen the right and left chain adjuster nuts ②.

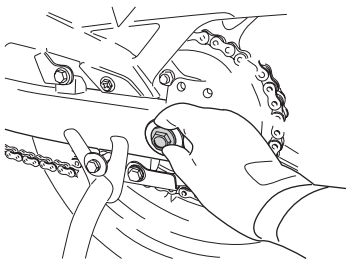

7. Draw out the axle shaft.

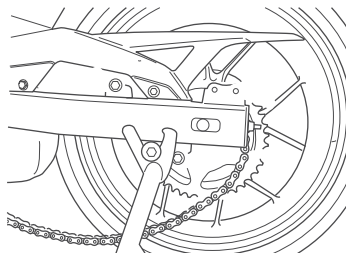

8. With the wheel moved forward, remove the chain from the sprocket.

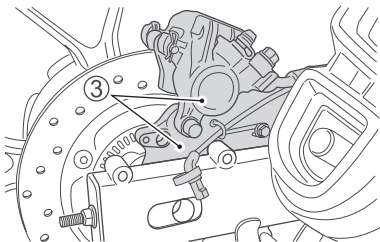

9. Remove the rear brake caliper assembly ③.

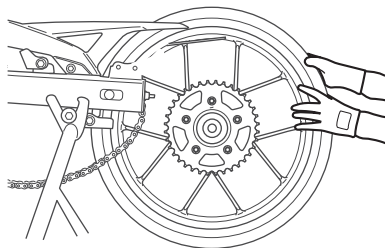

10. Pull the rear wheel assembly rearward.

NOTE: Never depress the rear brake pedal with the rear wheel removed. It is very difficult to force the pads back into the caliper assembly.

11. To replace the wheel reverse the complete sequence listed above.
12. Adjust the drive chain slack.
13. After installing the wheel, apply the brake several times and then check that the wheel rotates freely.

WARNING

Failure to adjust the drive chain and failure to torque axle nut properly could lead to an accident.

- Adjust the drive chain as described in **DRIVE CHAIN ADJUSTMENT** section after installing the rear wheel.
- Torque axle nut to the proper specifications. If you are not sure of the proper procedure, have your authorized Suzuki dealer or a qualified mechanic do this.

Rear axle nut tightening torque:
65 N·m (6.5 kgf·m)

WARNING

Failure to extend brake pads after installing the wheel can cause poor braking performance and may result in an accident.

Before riding, “pump” the brake pedal repeatedly until brake pads are pressed against the brake disks and proper pedal stroke and firm feel are restored. Also check that the wheel rotates freely.

LIGHT BULB REPLACEMENT

The wattage rating of each bulb is shown on the chart below. When replacing a burned out bulb, always use the exact same wattage rating. Using other than the specified rating can result in overloading the electrical system or premature failure of a bulb.

NOTICE

Failure to use a light bulb with the correct wattage rating can overload the electrical system of your motorcycle or cause the bulb to burn out sooner.

Use only the light bulbs shown in the chart as replacement bulbs.

| | |
|-------------------|---------|
| Turn signal light | 12V 10W |
|-------------------|---------|

HEADLIGHT BEAM ADJUSTMENT

The headlight beam can be adjusted up and down if necessary.

(GSX250RL)

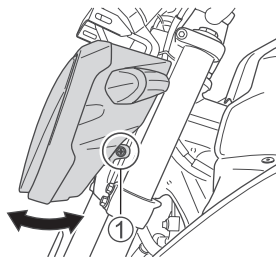

To adjust the beam up and down:

Loosen the headlight beam adjuster bolt ①. To adjust the beam, move the headlight forward or backward.

(GSX250FRL)

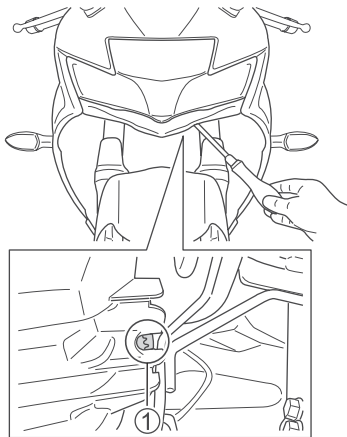

To adjust the beam up and down:

Turn the adjuster ① clockwise or counter-clockwise.

TURN SIGNAL LIGHT

To replace the turn signal light bulb, follow the procedure below.

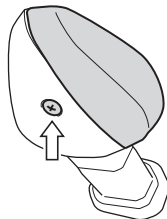

1. Remove the screw and lens.

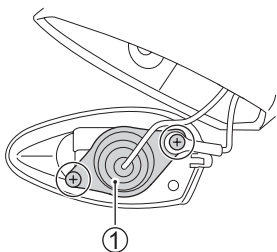

2. Remove the screws and take off the socket ①.

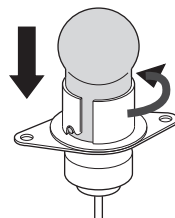

3. Push in on the bulb, twisting it to the left, and pull it out.
4. To fit the replacement bulb, push it in and twist it to the right while pushing.

NOTICE

Overtightening the screws when re-installing the lens may cause the lens to crack.

Tighten the screws only until they are snug.

FUSE

If something electrical on your motorcycle stops working, the first thing you should check for is blown fuse. The electrical circuits on the motorcycle are protected from overload by fuses in the circuits.

If a blown fuse is found, then the electrical problem must be inspected and repaired before replacing the blown fuse with a new fuse. Consult your Suzuki dealer for the electrical system check and repair.

WARNING

Replacing a fuse with a fuse that has an incorrect amperage rating or substitute, e.g. aluminum foil or wire, may cause serious damage to the electrical system and possibly fire. Always replace a blown fuse with a fuse of the same amperage rating.

If the new fuse blows in a short time, the electrical problem may not be fixed. Have your motorcycle inspected immediately by your Suzuki dealer.

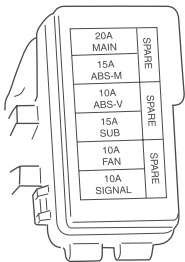

The fuses are located under the front seat. To access the fuses, remove the seat by referring to the SEAT LOCK AND HELMET HOLDERS section.

Three spare fuses (one 20A, one 15A and one 10A) are provided inside the fuse box.

FUSE LIST

- 20A MAIN fuse protects all electrical circuits.
- 15A SUB fuse protects the fuel indicator, oxygen sensor, solenoid, fuel pump, ignition coil, headlight low beam, headlight high beam, position light, license light, taillight, stop lamp, turn signal light, speedometer, horn, starter relay, starter sub relay, ECM and ABS.
- 10A SIGNAL fuse protects the speedometer, turn signal light, stop lamp, taillight, license light, position light, headlight high beam and headlight low beam.
- 10A FAN fuse protects the cooling fan relay.
- 15A ABS-M fuse protects the ABS system.
- 10A ABS-V fuse protects the ABS system.

CATALYTIC CONVERTER

The purpose of the catalytic converter is to minimize the amount of harmful pollutants in your motorcycle's exhaust. Use of leaded fuel in motorcycles equipped with catalytic converters is prohibited because lead deactivates the pollutant-reducing components of the catalyst system.

The converter is designed to last the life of the motorcycle under normal usage and when unleaded fuel is used. No special maintenance is required on the converter. However, it is very important to keep the engine properly tuned. Engine misfiring, which can result from an improperly tuned engine, may cause overheating of the catalyst. This may result in permanent heat damage to the catalyst and other motorcycle components.

WARNING

If you park or operate the motorcycle in areas where there are combustible materials such as dry grass or leaves, these materials may come in contact with the catalytic converter or other hot exhaust components. This can cause a fire.

Avoid parking or operating your motorcycle in areas with any combustible materials.

NOTICE

Improper motorcycle operation can cause catalyst or other motorcycle damage.

To avoid damage to the catalyst or other related components, you should take the following precautions:

- Maintain the engine in the proper operating condition.
- In the event of an engine malfunction, particularly one involving engine misfire or other apparent performance loss, stop riding the motorcycle and turn off the engine and have the motorcycle serviced promptly.
- Do not shut off the engine or interrupt the ignition when the transmission is in gear and the motorcycle is in motion.

- Do not try to start the engine by pushing the motorcycle or by coasting down a hill.
- Do not idle the engine with any spark plug wires disconnected or removed, such as during diagnostic testing.
- Do not idle the motorcycle for prolonged periods if idling seems rough or there are other malfunctions.
- Do not allow the fuel tank to get near the empty level.

TROUBLESHOOTING

| | |
|-----------------------------|-----|
| FUEL SUPPLY CHECK | 7-2 |
| IGNITION SYSTEM CHECK | 7-3 |
| ENGINE STALLING | 7-4 |

TROUBLESHOOTING

This troubleshooting guide is provided to help you find the cause of some common complaints.

NOTICE

Improper repairs or adjustments may damage the motorcycle instead of fixing it. Such damage may not be covered under warranty.

If you are not sure about the proper action, consult your Suzuki dealer about the problem.

If the engine refuses to start, perform the following inspections to determine the cause.

FUEL SUPPLY CHECK

If the odometer displays “FI” and malfunction indicator light comes on, trouble in the fuel injection system, take your machine to an authorized Suzuki dealer. Refer to the “INSTRUMENT PANEL” section for an explanation of the malfunction indicator light.

IGNITION SYSTEM CHECK

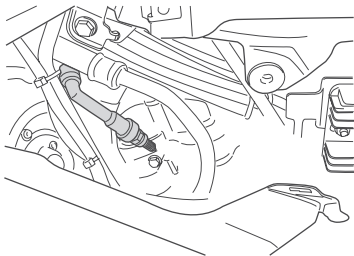

1. Remove the spark plug and reattach it to the spark plug cap.
2. While holding the spark plug firmly against the crank case of the engine, push the electric starter switch with the ignition switch in the "ON" position, the engine stop switch in the "O" position, the transmission in neutral, and the clutch disengaged. If the ignition system is operating properly, a blue spark should jump across the spark plug gap.
3. If there is no spark, clean the spark plug. Replace it if necessary. Retry the above procedure with the cleaned spark plug or a new one.
4. If there is still no spark, consult your Suzuki dealer for repairs.

⚠ WARNING

Performing the spark test improperly can be hazardous. You could get a high voltage electrical shock if you are not familiar with this procedure.

Do not perform this check if you are not familiar with the procedure. Do not point the spark plug near the spark plug hole during this test. Do not perform this test if you have a heart condition or wear a pacemaker.

ENGINE STALLING

1. Make sure there is enough fuel in the fuel tank.
2. If the odometer displays “FI” and malfunction indicator light comes on, trouble in the fuel injection system, take your machine to an authorized Suzuki dealer. Refer to the “INSTRUMENT PANEL” section for an explanation of the malfunction indicator light.
3. Check the ignition system for intermittent spark.
4. Check the idle speed.



STORAGE PROCEDURE AND MOTORCYCLE CLEANING

| | |
|--|-----|
| STORAGE PROCEDURE | 8-2 |
| PROCEDURE FOR RETURNING TO SERVICE | 8-3 |
| CORROSION PREVENTION | 8-4 |
| MOTORCYCLE CLEANING | 8-5 |
| INSPECTION AFTER CLEANING | 8-9 |

STORAGE PROCEDURE AND MOTORCYCLE CLEANING

STORAGE PROCEDURE

If the motorcycle is to be left unused for extended period of time for winter storage or any other reason, the machine needs special servicing requiring appropriate materials, equipment and skill. For this reason, Suzuki recommends that you trust this maintenance work to your Suzuki dealer. If you need to service the machine for storage yourself, follow the general guidelines as follows.

MOTORCYCLE

Clean the entire motorcycle. Place the motorcycle on the side stand on a firm, flat surface where it will not fall over. Turn the handlebars all the way to the left and lock the steering, and remove the ignition key.

FUEL

1. Fill the fuel tank to the top with fuel mixed with the amount of gasoline stabilizer recommended by the stabilizer manufacturer.
2. Run the engine for a few minutes until the stabilized gasoline fills the fuel injection system.

ENGINE

1. Pour one tablespoon of motor oil into the spark plug hole. Reinstall the spark plug and crank the engine a few times.
2. Drain the engine oil thoroughly and fill the crankcase with the fresh engine oil all the way up to the filler hole.
3. Cover the air cleaner intake and the muffler outlet with oily rags to prevent humidity from entering.

BATTERY

1. Remove the battery from the motorcycle by referring to the BATTERY section.
2. Clean the outside of the battery with a mild soap and remove corrosion from the terminals and wiring harness.
3. Store the battery in a room above freezing.

TYRE

Inflate the tyres to the normal specifications.

EXTERNAL

- Spray all vinyl and rubber parts with rubber preservative.
- Spray the unpainted surfaces with rust preventative.
- Coat the painted surfaces with car wax.

MAINTENANCE DURING STORAGE

Once a month, recharge the battery by referring to the BATTERY section. If you cannot charge the battery, consult your authorized Suzuki dealer.

PROCEDURE FOR RETURNING TO SERVICE

1. Clean the entire motorcycle.
2. Remove the oily rags from the air cleaner intake and muffler outlet.
3. Drain all the engine oil. Install a new oil filter and fill the engine with fresh oil as outlined in this manual.
4. Remove the spark plug. Turn the engine a few times. Reinstall the spark plug.
5. Reinstall the battery by referring to the BATTERY section.
6. Make sure that the motorcycle is properly lubricated.
7. Perform the INSPECTION BEFORE RIDING as listed in this manual.
8. Start the motorcycle as outlined in this manual.

CORROSION PREVENTION

It is important to take good care of your motorcycle to protect it from corrosion and keep it looking new for years to come.

Important Information About Corrosion

Common causes of corrosion

- Accumulation of road salt, dirt, moisture, or chemicals in hard-to-reach areas.
- Chipping, scratches, and any damage to treated or painted metal surfaces resulting from minor accidents or impacts from stones and gravel.

Road salt, sea air, industrial pollution, and high humidity will all contribute to corrosion.

How to Help Prevent Corrosion

- Wash your motorcycle frequently, at least once a month. Keep your motorcycle as clean and dry as possible.
- Remove foreign material deposits. Foreign material such as road salt, chemicals, road oil or tar, tree sap, bird droppings and industrial fall-out may damage your motorcycle's finish. Remove these types of deposits as quickly as possible. If these deposits are difficult to wash off, an additional cleaner may be required. Follow the manufacturer's directions when using these special cleaners.
- Repair finish damage as soon as possible. Carefully examine your motorcycle for damage to the painted surfaces. Should you find any chips or scratches in the paint, touch them up immediately to prevent corrosion from starting. If the chips or scratches have gone through to the bare metal, have a Suzuki dealer make the repair.

- Store your motorcycle in a dry, well-ventilated area. If you often wash your motorcycle in the garage or if you frequently park it inside when wet, your garage may be damp. The high humidity may cause or accelerate corrosion. A wet motorcycle may corrode even in a heated garage if the ventilation is poor.
- Cover your motorcycle. Exposure to mid-day sun can cause the colours in paint, plastic parts, and instrument faces to fade. Covering your motorcycle with a high-quality, “breathable” motorcycle cover can help protect the finish from the harmful UV rays in sunlight, and can reduce the amount of dust and air pollution reaching the surface. Your Suzuki dealer can help you select the right cover for your motorcycle.

MOTORCYCLE CLEANING

WASHING THE MOTORCYCLE

When washing the motorcycle, follow the instruction below:

1. Remove dirt and mud from the motorcycle with cool running water. You may use a soft sponge or brush. Do not use hard materials which can scratch the paint.
2. Wash the entire motorcycle with a mild detergent or car wash soap using a sponge or soft cloth. The sponge or cloth should be frequently soaked in the soap solution.

NOTE: Clean the motorcycle with cool water immediately after riding on road salt or riding along the coast. Be sure to use cool water because warm water can hasten corrosion.

NOTE: Avoid spraying or allowing water to flow over the following places:

- Ignition switch
- Spark plug
- Fuel tank cap
- Brake master cylinders
- Throttle cable boots
- Fuel injection system
- Oil cooler
- Steering head tube upper and lower

NOTICE

High pressure washers such as those found at coin-operated car washes have enough pressure to damage the parts of your motorcycle. It may cause rust, corrosion and increase wear. Parts cleaner can also damage motorcycle parts.

Do not use high pressure washers to clean your motorcycle. Do not use parts cleaner on throttle body and electric parts.

3. Once the dirt has been completely removed, rinse off the detergent with running water.
4. After rinsing, wipe off the motorcycle with a wet chamois or cloth and allow it to dry in the shade.
5. Check carefully for damage to painted surfaces. If there is any damage, obtain “touch-up” paint and “touch-up” the damage following the procedure below:
 - a. Clean all damaged spots and allow them to dry.
 - b. Stir the paint and “touch-up” the damaged spots lightly with a small brush.
 - c. Allow the paint to dry completely.

NOTE: The headlight lens can be fogged after washing the motorcycle or riding in the rain. Headlight fogging will be cleared gradually when the headlight is turned on. When clearing the headlight lens fogging, run the engine to avoid battery discharge.

NOTICE

Cleaning your motorcycle with any alkaline or strong acid cleaner, gasoline, brake fluid, or any other solvent will damage the motorcycle parts.

Clean only with soft cloth and warm water with mild detergent.

PLASTIC PARTS

Plastic parts such as headlight lens, speedometer display, windshield and fairing, are easy to be damaged. When such part is cleaned, wash it using water after cleaning it using neutral detergent or soapy water, and wipe it with a soft cloth.

WARNING

Do not put anything between the fairing and steering.

If so, it will negatively affect the steering operation.

NOTICE

When any of the following substances is attached to the plastic part such as headlight lens, speedometer display or windshield, it might cause a scratch or damage to the part.

- Wax compound
- Chemical supplies such as oil film removing agent or repellents
- Acidic or alkaline detergent
- Brake fluid, gasoline or organic solvent, etc.

WAXING THE MOTORCYCLE

After washing the motorcycle, waxing and polishing are recommended to further protect and beautify the paint.

- Only use waxes and polishes of good quality.
- When using waxes and polishes, observe the precautions specified by the manufacturers.

SPECIAL CARE FOR MATTE FINISH PAINT

Do not use polishing compounds or waxes that contain polishing compounds on surfaces which have a matte finish. The use of polishing compounds will change the appearance of the matte finish.

Solid type waxes may be difficult to remove from surfaces with a matte finish.

Friction while riding, excessive rubbing or polishing of a surface with a matte finish will change its appearance.

INSPECTION AFTER CLEANING

For extended life of your motorcycle, lubricate according to the “LUBRICATION POINTS” section.

WARNING

Operating the motorcycle with wet brakes can be hazardous. Wet brakes may not provide as much stopping power as dry brakes. This could lead to an accident.

Test your brakes after washing the motorcycle, while riding at slow speed. If necessary, apply the brakes several times to let friction dry out the linings.

Follow the procedures in the “INSPECTION BEFORE RIDING” section to check your motorcycle for any problems that may have arisen during your last ride.



SPECIFICATIONS

SPECIFICATIONS.....9-2

SPECIFICATIONS

DIMENSIONS AND KERB MASS

| | |
|----------------------|---|
| Overall length | 2010 mm |
| Overall width..... | 805 mm ... GSX250RL 740 mm ... GSX250FRL |
| Overall height | 1035 mm |
| Wheelbase | 1340 mm ... GSX250RL 1345 mm ... GSX250FRL |
| Kerb mass | 156 kg ... GSX250RL 160 kg ... GSX250FRL |

ENGINE

| | |
|--------------------------|------------------------------|
| Type | Four-stroke, oil-cooled, OHC |
| Number of cylinder | 1 |
| Bore | 76.0 mm |
| Stroke | 54.9 mm |
| Displacement..... | 249 cm ³ |
| Compression ratio | 10.7 : 1 |
| Fuel system | Fuel injection |
| Air cleaner | Non-woven fabric element |
| Starter system | Electric |
| Lubrication system | Wet sump |

DRIVE TRAIN

| | |
|-------------------------------|----------------------------|
| Clutch | Wet multi-plate type |
| Transmission | 6-speed constant mesh |
| Gearshift pattern | 1-down, 5-up |
| Primary reduction ratio | 3.086 (71/23) |
| Gear ratios, Low | 2.500 (30/12) |
| 2nd..... | 1.687 (27/16) |
| 3rd..... | 1.315 (25/19) |
| 4th..... | 1.111 (20/18) |
| 5th..... | 0.954 (21/22) |
| Top..... | 0.826 (19/23) |
| Final reduction ratio..... | 3.076 (40/13) |
| Drive chain | DAIDO DID520VF3, 108 links |

CHASSIS

| | |
|------------------------|---|
| Front suspension | Telescopic, coil spring, oil damped |
| Rear suspension | Swingarm type, coil spring, oil damped, spring pre-load |
| Front brake | Disk brake |
| Rear brake..... | Disk brake |
| Front tyre size..... | 110/70R17 M/C 54S, tubeless |
| Rear tyre size | 150/60R17 M/C 66S, tubeless |

ELECTRICAL

| | |
|---|--------------------------------------|
| Ignition type | Electronic ignition (Transistorized) |
| Spark plug | NGK MR8E-9 |
| Battery | 12V 21.6kC (6.0 Ah)/10HR |
| Generator | Three-phase A.C. generator |
| Fuse | 20/15/10/10A |
| ABS fuse | 15/10A |
| Headlight | LED |
| Position light | LED |
| Brake light/Taillight..... | LED |
| Turn signal light | 12V 10W |
| License plate light..... | LED |
| Instrument panel..... | LED |
| Turn signal indicator light..... | LED |
| Neutral indicator light..... | LED |
| High beam indicator light..... | LED |
| Engine RPM indicator light..... | LED |
| ABS indicator light..... | LED |
| Malfunction indicator light..... | LED |
| Engine temperature indicator light..... | LED |

CAPACITIES

| | |
|-----------------------------|---------|
| Fuel tank..... | 12.0 L |
| Engine oil, oil change..... | 1180 ml |
| With filter change | 1200 ml |
| Overhaul..... | 1800 ml |



INDEX

- A**
ACCESSORY USE AND MOTORCYCLE
LOADING..... 1-2
AIR CLEANER..... 6-20
AVOID CONSTANT LOW SPEED 4-3
- B**
BATTERY 6-15
BRAKES 6-44
BREAKING IN THE NEW TYRES 4-3
- C**
CATALYTIC CONVERTER 6-71
CLUTCH 6-38
CORROSION PREVENTION 8-4
- D**
DRIVE CHAIN..... 6-39
- E**
ENGINE OIL 3-4, 6-30
ENGINE STALLING 7-4
- F**
FAIRING REMOVAL (GSX250FRL)..... 6-9
FRAME COVER REMOVAL
(GSX250RL) 6-7
FUEL HOSE 6-29
FUEL OCTANE RATING..... 3-2
FUEL SUPPLY CHECK..... 7-2
FUEL TANK CAP 2-29
FUSE 6-69
- G**
GEARSHIFT LEVER 2-30

I

| | |
|--------------------------------|-----|
| IGNITION SWITCH..... | 2-5 |
| IGNITION SYSTEM CHECK | 7-3 |
| INSPECTION AFTER CLEANING..... | 8-9 |
| INSPECTION BEFORE RIDING | 4-4 |
| INSTRUMENT PANEL | 2-8 |

K

| | |
|----------|-----|
| KEY..... | 2-5 |
|----------|-----|

L

| | |
|-----------------------------|------|
| LABELS | 1-6 |
| LEFT HANDLEBAR | 2-24 |
| LIGHT BULB REPLACEMENT..... | 6-66 |
| LOCATION OF PARTS | 2-2 |
| LUBRICATION POINTS | 6-13 |

M

| | |
|---|-----|
| MAINTENANCE SCHEDULE..... | 6-2 |
| MAXIMUM THROTTLE OPENING RECOMMENDATION..... | 4-2 |
| MODIFICATION | 1-4 |
| MOTORCYCLE CLEANING..... | 8-5 |

O

| | |
|---|-----|
| OBSERVE YOUR FIRST AND MOST CRITICAL SERVICE | 4-4 |
| OXYGENATED FUEL RECOMMENDATION..... | 3-2 |

P

| | |
|--|-----|
| PROCEDURE FOR RETURNING TO SERVICE..... | 8-3 |
|--|-----|

| | | | |
|--|------|--------------------------------|------|
| R | | | |
| REAR BRAKE PEDAL..... | 2-31 | | |
| REAR SUSPENSION | 2-36 | | |
| REAR WHEEL REMOVAL | 6-61 | | |
| RIDING ON HILLS..... | 5-7 | | |
| RIGHT HANDLEBAR..... | 2-26 | | |
| | | | |
| S | | | |
| SAFE RIDING RECOMMENDATION FOR MOTORCYCLE RIDERS..... | 1-5 | | |
| SEAT LOCK AND HELMET HOLDERS..... | 2-32 | | |
| SERIAL NUMBER LOCATION | 1-7 | | |
| SIDE STAND | 2-35 | | |
| SPARK PLUG..... | 6-25 | | |
| STARTING OFF | 5-4 | | |
| STARTING THE ENGINE..... | 5-2 | | |
| STOPPING AND PARKING | 5-8 | | |
| STORAGE PROCEDURE | 8-2 | | |
| | | | |
| | | T | |
| | | THROTTLE CABLE ADJUSTMENT..... | 6-36 |
| | | TOOLS | 6-6 |
| | | TYRES..... | 6-52 |
| | | | |
| | | U | |
| | | USING THE TRANSMISSION..... | 5-6 |
| | | | |
| | | V | |
| | | VARY THE ENGINE SPEED..... | 4-2 |



Warranty System



WARRANTY COVERAGE

FOR ALL MODELS

24 months or 20,000km
whichever comes first

EXPENDABLE PARTS NOT COVERED BY WARRANTY

- Spark plugs
- Lamp bulbs
- Fuses
- Rubber parts except engine oil seals
- Bolts, nuts, washers
- Brake / clutch linings
- Cables
- Gaskets
- Tires and inner tubes
- Mags
- Spokes
- Sprockets (Engine and wheel)
- Drive chain / V-belt
- Battery

CONDITIONS NOT COVERED BY WARRANTY

- Units that have not undergone required periodic inspection.
- Units serviced by mechanics not authorized by Suzuki.
- Units damaged by use of parts other than Suzuki Genuine Parts.
- Damages caused by users negligence or abuse.
- Delivery or transport problems.
- Changes or alterations in the unit not recommended by Suzuki.
- Accidents, collisions, over-revolution of engine, racing...
- Use of fuel and oil not recommended by Suzuki.
- Trouble caused by breaking a seal or disassembling any unremovable parts such as ECM, CDI unit, switches, speedometer, oil pump, fuel pump, etc.
- Trouble caused by inappropriate care (Rusting, fading of color, natural deterioration, etc.)

SERVICE RECORD

Reliability and performance depend on the special care and maintenance of your motorcycle. Visit your dealers for Periodic Maintenance Service when your motorcycle has reached the specified number of month/s or kilometer reading (whichever comes first) as shown below.

| | | | | | |
|--------------|--|-------|--|----------------|--|
| Owner's Name | | | | Dealer Name | |
| Address | | | | Address | |
| Model | | Color | | Date Purchased | |
| Eng No. | | | | Frame No. | |

| 1st Month (1,000 km) Service | | | | | | |
|------------------------------|------------------------------|-----------------------------|---------------------------|------------------------------|-----------------------------|------------------------|
| Service Date | | | Km Reading | | JO No. | |
| Servicing Dealer / Address | | | | | | |
| Mechanic Name / Signature | | | Customer Name / Signature | | | |
| Replaced Oil? | <input type="checkbox"/> YES | <input type="checkbox"/> NO | Replaced Oil filter? | <input type="checkbox"/> YES | <input type="checkbox"/> NO | If YES what oil brand? |

4th Month (4,000 km) Service

| | | | | | |
|----------------------------|---|---------------------------|---|------------------------|--|
| Service Date | | Km Reading | | JO No. | |
| Servicing Dealer / Address | | | | | |
| Mechanic Name / Signature | | Customer Name / Signature | | | |
| Replaced Oil? | <input type="checkbox"/> YES <input type="checkbox"/> NO | Replaced Oil filter? | <input type="checkbox"/> YES <input type="checkbox"/> NO | If YES what oil brand? | |

8th Month (8,000 km) Service

| | | | | | |
|----------------------------|---|---------------------------|---|------------------------|--|
| Service Date | | Km Reading | | JO No. | |
| Servicing Dealer / Address | | | | | |
| Mechanic Name / Signature | | Customer Name / Signature | | | |
| Replaced Oil? | <input type="checkbox"/> YES <input type="checkbox"/> NO | Replaced Oil filter? | <input type="checkbox"/> YES <input type="checkbox"/> NO | If YES what oil brand? | |

12th Month (12,000 km) Service

| | | | | | |
|----------------------------|---|---------------------------|---|------------------------|--|
| Service Date | | Km Reading | | JO No. | |
| Servicing Dealer / Address | | | | | |
| Mechanic Name / Signature | | Customer Name / Signature | | | |
| Replaced Oil? | <input type="checkbox"/> YES <input type="checkbox"/> NO | Replaced Oil filter? | <input type="checkbox"/> YES <input type="checkbox"/> NO | If YES what oil brand? | |

16th Month (16,000 km) Service

| | | | | | |
|----------------------------|---|---------------------------|---|------------------------|--|
| Service Date | | Km Reading | | JO No. | |
| Servicing Dealer / Address | | | | | |
| Mechanic Name / Signature | | Customer Name / Signature | | | |
| Replaced Oil? | <input type="checkbox"/> YES <input type="checkbox"/> NO | Replaced Oil filter? | <input type="checkbox"/> YES <input type="checkbox"/> NO | If YES what oil brand? | |

24th Month (20,000 km) Service

| | | | | | |
|----------------------------|---|---------------------------|---|------------------------|--|
| Service Date | | Km Reading | | JO No. | |
| Servicing Dealer / Address | | | | | |
| Mechanic Name / Signature | | Customer Name / Signature | | | |
| Replaced Oil? | <input type="checkbox"/> YES <input type="checkbox"/> NO | Replaced Oil filter? | <input type="checkbox"/> YES <input type="checkbox"/> NO | If YES what oil brand? | |



